

# PROEVAC EVO

## EN54-16 Voice Alarm System

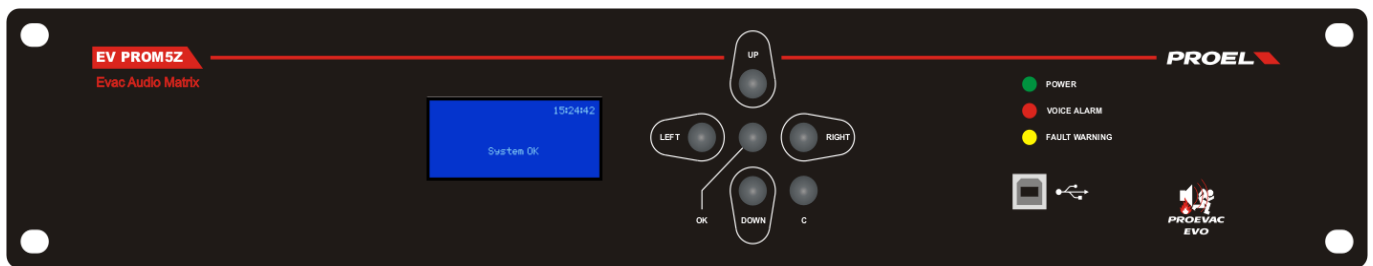

USER AND INSTALLATION MANUAL



This page is intentionally left blank

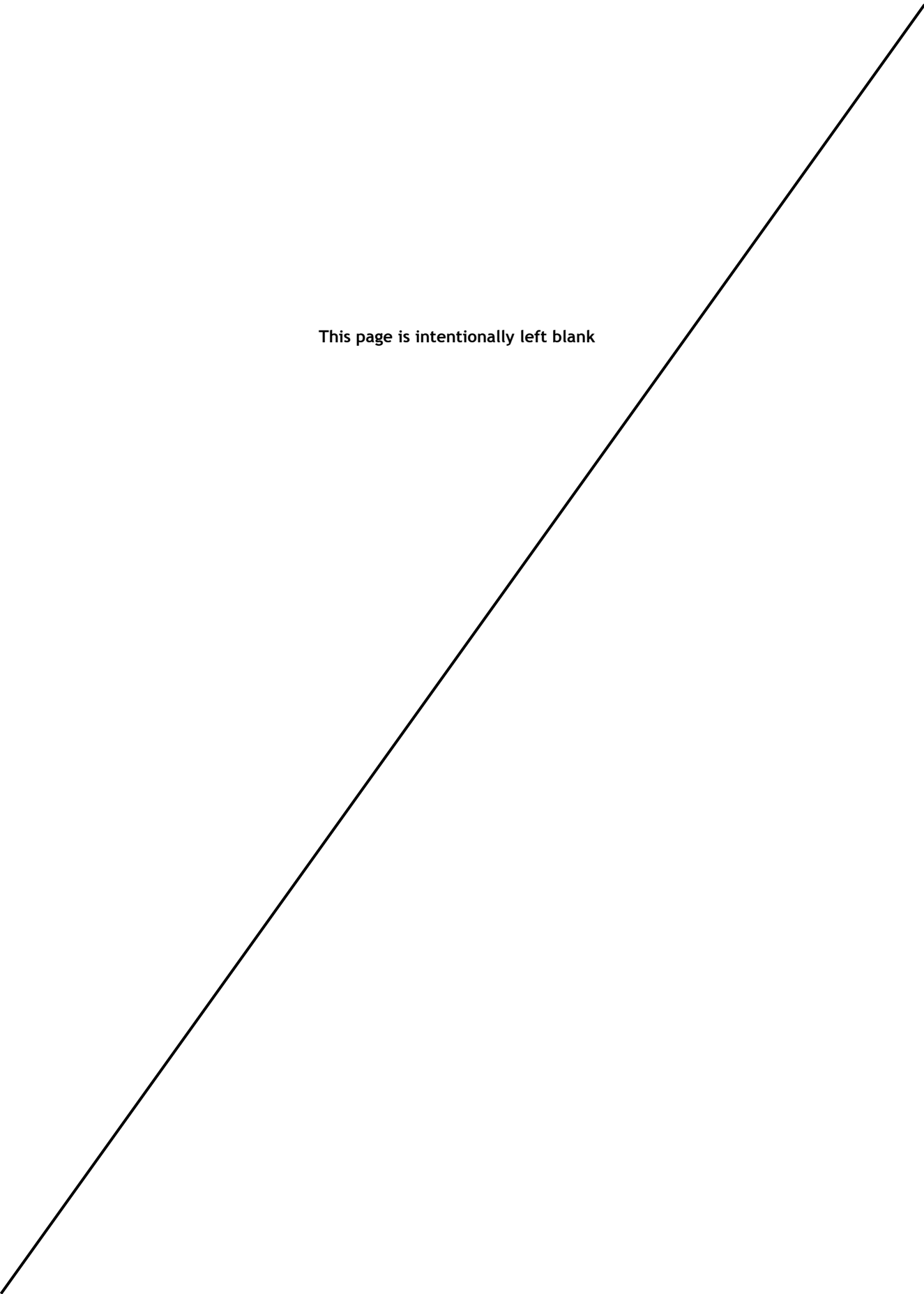

Firmware revision: 1.10.12.13  
Document: USRM\_PROEVAC EVO\_IT\_14 Rev. 0.01  
Issued by: MF  
Checked by: PF  
Approved by: RF

Revision History

Rel.	Data	Author - Modifications
1.00	10/10/15	Translation from mother language manual Rev 3.00



Certified Quality Management System  
ISO9001:2008  
Reg. N. 50 100 5745



This page is intentionally left blank

## CONTENTS

1. GENERAL DESCRIPTION
  - 1.1 Introduction
  - 1.2 List of main features and functions
  - 1.3 System access
  - 1.4 Explanation of symbols
2. SAFETY INSTRUCTIONS AND CARE OF THE PRODUCT
3. VISUAL IDENTIFICATION OF CONNECTIONS AND USER KEYS
  - 3.1 EV PROM5Z Master unit
  - 3.2 EV PROS8Z Slave unit
  - 3.3 EV MCL1Z Line-A main controller module
  - 3.4 EV MCL2Z Line-B redundant controller module
  - 3.5 Microphone stations
4. DESCRIPTION OF CONNECTION AND SYSTEM ASSEMBLY
  - 4.1 Power supply connection
  - 4.2 Installation of the line modules in Master and Slave units
  - 4.3 Connection of the Master unit to one or more Slaves
  - 4.4 Spare amplifier wiring on Master and Slave units
  - 4.5 Wiring the line A module
  - 4.6 Wiring the line B module
  - 4.7 Wiring and configuring the microphone stations
  - 4.8 Replacing the clock battery
  - 4.9 uSD memory card installation
  - 4.10 Completing the system
5. DESCRIPTION AND IDENTIFICATION OF THE SYSTEM STATUS
6. SYSTEM MENU
  - 6.1 Menu navigation
  - 6.2 Menu tree
  - 6.3 Description of the system's menus
  - 6.4 Logs table
7. OPERATIONS AND PROCEDURES
  - 7.1 Access levels authentication
  - 7.2 Silencing a zone
  - 7.3 Calibrating a line
  - 7.4 Restoring the primary amplifier
  - 7.5 Background music volume
  - 7.6 Cancelling the logs
  - 7.7 System indicators test
  - 7.8 Setting date and time
  - 7.9 Configuration download
8. USING THE MICROPHONE STATIONS
  - 8.1 Common features to all models
  - 8.2 EV BME1T
  - 8.3 WG-MTU06
  - 8.4 EV BME10T
9. TECHNICAL SPECIFICATIONS
10. CERTIFICATIONS



## 1. GENERAL DESCRIPTION

### 1.1 Introduction

Proevac is a modular, digitally controlled, voice alarm system. It's main purpose is to send spoken, live or recorded, voice evacuation messages. Proevac was designed and certified according to EN 54-16 specification in order to grant a high quality and high intelligibility sound.

The modularity and scalability of Proevac allow to configure it in order to be tailored according to the building requirements thanks to the high number of zone that can be fitted and thanks to the high output power that can be handled by each zone.

The internal four channelmatrix arrangement allow to sent up to four audio contents or general purpose audio messages on different group of zones.

The system core is the **Master EV PROM5Z** unit that manages all audio flows and performs the monitoring of the whole setup. All functions related to the each zone are managed by the **EV MCL1Z** modules that are fitted into the Master EV PROM5Z and Slave EV PROS8Z units and connected to an external power amplifier. Thus, each zone has its own dedicated power amplifier that is managed independently from all others. This feature allows to set up each zone with a power amplifier that best suits the design demands of the electrics of the building with a power handling up to 500 Wrms.

The EV PROM5Z Master unit can handle up to 5 zone controller modules and EV PROS8Z Slave unit can be fitted with up to 8 zone controllers. Slave units are daisy-chained to the Master allowing thus to configure the system up to 108 zones.

Additionally, each Master and Slave unit can handle a spare amplifier that switches over in case of a failure to a zone amplifier.

Each EV MCL1Z zone controller has an embedded memory where two independent messages are stored. Recorded messages are triggered by two monitored input contacts. This particular feature allows to send a dedicated alarm message on each single zone. This means that in case of a fire alarm on a 108 zones system, the equipment will play 108 different messages all together.

Finally, each zone module has its own independent volume and tone control.

The monitoring of the loudspeaker line and related power amplifier is achieved with a tone above the audio band through a FFT algorithm that allows the system to constantly keep under control both amplifier and loudspeakers without interfering with the voice message or background music that is being played and without them to interfere with the monitoring itself. The monitoring is so accurate that it able to catch very small variations of the applied load thanks to a sophisticated algorithm that follows and compensates both environmental parameters and load drifts. The monitoring functions of the EV MCL1Z module include a detection of ground leakage of the loudspeaker line.

Where the design of the voice alarm system foresees loudspeaker line redundancy on some (or all) zones, the main EV MCL1Z zone controller can be matched to the secondary line controller **EV MCL2Z**. The main line controller drives and monitors the power amplifier and manages the first loudspeaker line (line A) while the secondary zone controller takes power from the same amplifier and distributes it to the second loudspeaker line (line B) performing load and impedance monitoring. In case of a failure to one of the two lines, the faulty line is disconnected and power is eventually increased on the healthy line in order to maintain a constant sound pressure inside the room.

All sound contents are processed by the EV PROM5Z Master that acts as a central sorting device from the inputs to the zone controllers. The master unit has two input ports from two independent groups of microphone stations connected in parallel in a bus fashion. Each bus carries audio, data channel and power. The Master unit constantly monitors the performance of the microphone stations through an integrity check of the communication bus. All microphone stations of the Proevac system can be configured as a voice alarm call station, or for general announcements. In the first case, if a failure occurs in whatever part of audio or data path, from the microphone capsule to the Master unit, the system will promptly report a fault.

Proevac has different models of microphone stations: **EV BME1T** and **WG-EFM10** have a single direct access key and are typically used desktop or wall-mount emergency call stations. **WG-MTU06** and **EV BME10T** allow superior flexibility thanks to their advanced user interface and are both configurable for general announcements or as emergency call stations.

The functions of all microphone station, their access priority to the zones of the system is defined at the time of the configuration of the whole system through the BEST ("Basic voice Emergency Setup Tool") software.

In addition to all described functions, the Proevac system can play two or more recorded alarm messages that are common to all zones. These messages are triggered by two monitored inputs on the master unit. The master unit as an embedded scheduled message player for non-fire-alarm purposes that may be useful, for example in a shopping mall to play commercials, welcome announcements, etc... Finally, the EV PROM5Z master unit has dedicated relay outputs for state reporting to other fire devices, dedicated inputs to report the state of an external power supply and a background music RCA input.





## 1.2 List of main features and functions

- Digitally controlled and configurable voice alarm and public address audio system; up to 108 zones
- 4 lines matrix arrangement
- 2x independent messages for each zone stored inside a mass memory on the EV MCL1Z module
- Unlimited number of addressable messages, up to the storage capacity of the internal uSD card
- 2x monitored input contacts on EV PROM5Z master unit and 2x monitored input contacts on each EV MCL1Z for alarm or general purpose message triggering
- Continuous and independent monitoring of each zone loudspeaker line and power amplifier performed by the EV MCL1Z module
- Continuous and independent monitoring of redundant loudspeaker line (line B) performed by EV MCL2Z module
- Continuous and independent monitoring of redundant loudspeaker line ground leakage
- Automatic calibration of loudspeaker lines and load applied to the power amplifier volume
- Automatic output level setting of the power amplifier to reach 100V on loudspeaker line
- Spare amplifier connections on EV PROM5Z master and EV PROS8Z slave units
- Independent volume and tone control over each zone
- Independent volume and tone control of each audio content, general or alarm
- Enablement, volume and tone control of background music on each zone.
- Five level priority management of ever audio content addressable to zones or group of zones
- System functions and configuration on password protected access levels according to EN54-16 requirements
- Acoustic and visual reporting of the system's status
- Alarm message silencing independently on each zone.
- Up to 54 microphone stations on two independent busses. A total of 108 microphone stations are allowed.
- Continuous monitoring of audio path of all microphone stations; all models can be used as alarm call stations or for general announcement purposes.
- Automatic logging of all system's events on the internal uSD memory card.
- Conversion of all digital audio formats on the BEST software.
- Automatic validation of the hardware setup and congruency with the designed system in the BEST software.
- Extension slot on the EV PROM5Z Master unit.
- 2x input contacts for power supply state reporting
- 2x replay contacts for state reporting to other devices

## 1.3 System Access

Accessing the system is allowed to predefined figures only. These are identified inside this manual by the following symbols that are associated with their respective duties.





Access to functions which refer to the three figures listed here is password protected.

	<p><b>ACCESS LEVEL 3: INSTALLER or MAINTAINER</b></p> <p>is the one who defines the system configuration, performs site-specific system design, wires the system and/or takes care of the technical support.</p>
	<p><b>ACCESS LEVEL 2: SECURITY GUARD</b></p> <p>all persons having a specific responsibility for safety and who are trained and authorized to operate the system.</p>
	<p><b>ACCESS LEVEL 1: USER</b></p> <p>is a member of the general public or person having a general responsibility for safety supervision who might be expected to investigate and initially respond to a fire alarm or fault warning.</p>

**NOTE:** The access restrictions to the system by the three figures listed above are not exclusive, but are intended as cascaded. The user is only allowed to access level 1, the security guard is allowed to access levels 1 and 2, and the installer can access all levels.

## 1.4 Explanation of symbols

In addition to the symbols that identify the persons allowed to operate the system, below are some icons that will focus on important aspects and features related to the system.

	<b>USEFUL INFORMATION</b> This symbol identifies an information that may be useful in the use or configuration of the system.
	<b>TIP</b> This symbol identifies a tip or an application example.
	<b>WARNING/DANGER</b> This symbol indicates a specific aspect, feature or action that requires special care or attention since a negligence would lead to a situation of danger, malfunction or deterioration in the performance of the system.
	<b>ELECTRIC SHOCK</b> This symbol indicated a situation in which the user/maintainer/installer may be exposed to a risk of electric shock









## 2. SAFETY INSTRUCTIONS AND CARE OF THE PRODUCT

These instructions are for use by qualified service personnel that shall perform the installation and servicing of the units of the Proevac system.

Please, read carefully this user manual and the safety instructions related to the product.

Keep these instructions and the product user manual

Heed all indications contained herein and in the user manual

	<p><b>ELECTRIC SHOCK</b></p> <p>In order to reduce the risk of electric shock, do not remove the top cover of the unit or the covers/modules on the back of the unit when the equipment is powered.</p> <p>Remove the top cover to access the inside of the units only when the equipment is unpowered</p> <p>Do not perform any servicing operation that is not contained in the operation instructions.</p>
	<p><b>WARNING</b></p> <p>Do not expose the unit to moisture or rain.</p> <p>Install the equipment so that no liquids flow inside</p> <p>Do not locate near objects filled with liquids that may accidentally pour on the equipment.</p> <p>Do not block any ventilation openings. During installation, please ensure that the units are sufficiently ventilated.</p> <p>Do not install the equipment near heat sources such as radiators, heat registers, stoves or the apparatus (including amplifiers) that produce heat.</p>
	<p><b>CARE AND MAINTENANCE</b></p> <p>Unpower the equipment before performing any of the following operations:</p> <ul style="list-style-type: none"> <li>• Clean the equipment with a dry cloth</li> <li>• Check periodically the ventilation opening for obstructions and dirt.</li> <li>• Clean the ventilation openings with a vacuum-cleaner</li> <li>• Check periodically all cables and connections.</li> <li>• Check periodically the presence and effectiveness of ground connection.</li> </ul>
	<p><b>FAILURE OR DAMAGE</b></p> <p>Contact your dealer or qualified service center in case the equipment is found damaged or in case of a failure such as:</p> <ul style="list-style-type: none"> <li>• Unit has been dropped or exposed to mechanical shock.</li> <li>• Unit shows a state of decay or alteration of performance.</li> <li>• A foreign object is detected inside the equipment.</li> <li>• Liquid has been spilled inside the equipment.</li> <li>• Unit has been exposed to rain or moisture</li> <li>• Cables or connectors carrying power (power supply, amplifier outputs or speaker lines) are damaged.</li> </ul>
	<p><b>BATTERY SUBSTITUTION</b></p> <p>The EV PROM5Z unit has a CR2032 battery for the internal real time clock and calendar. It is advisable to change the battery every 24 months. Please refer to user manual for detailed instructions.</p>
	<p><b>CHECK OF LOUDSPEAKER LINE IMPEDANCE DRIFT</b></p> <p>In order to check the loudspeaker lines impedance drift with respect to the initial calibration, it is advisable to periodically reset the equipment by unpowering and powering it. The time between one reset operation and another is the responsibility of the safety officer based on the assessments of the risks for the building. We, the manufacturer suggest to perform a reset operation once every 12 months.</p>
	<p><b>AUTHENTICITY OF THE USER MANUAL AND RELATED DOCUMENTATION</b></p> <p>This manual is an integral part of the Proevac system, designed and manufactured by Sotis Engineering Srl. His presence in paper and/or electronic form is guaranteed by the manufacturer during the packaging of the product. Sotis Engineering disclaims any liability, direct, or indirect, about the product and any other equipment connected or wired to it in case the system is configured and operated referring to other manuals or documentation different than the present, or whenever this manual, related documents and application notes, are issued or modified by third parties without the authorization of Sotis Engineering. It is therefore expressly forbidden by anyone to alter or make changes of any kind in this manual.</p>

### 3. VISUAL IDENTIFICATION OF CONNECTIONS AND USER KEYS

#### 3.1 EV PROM5Z Master unit

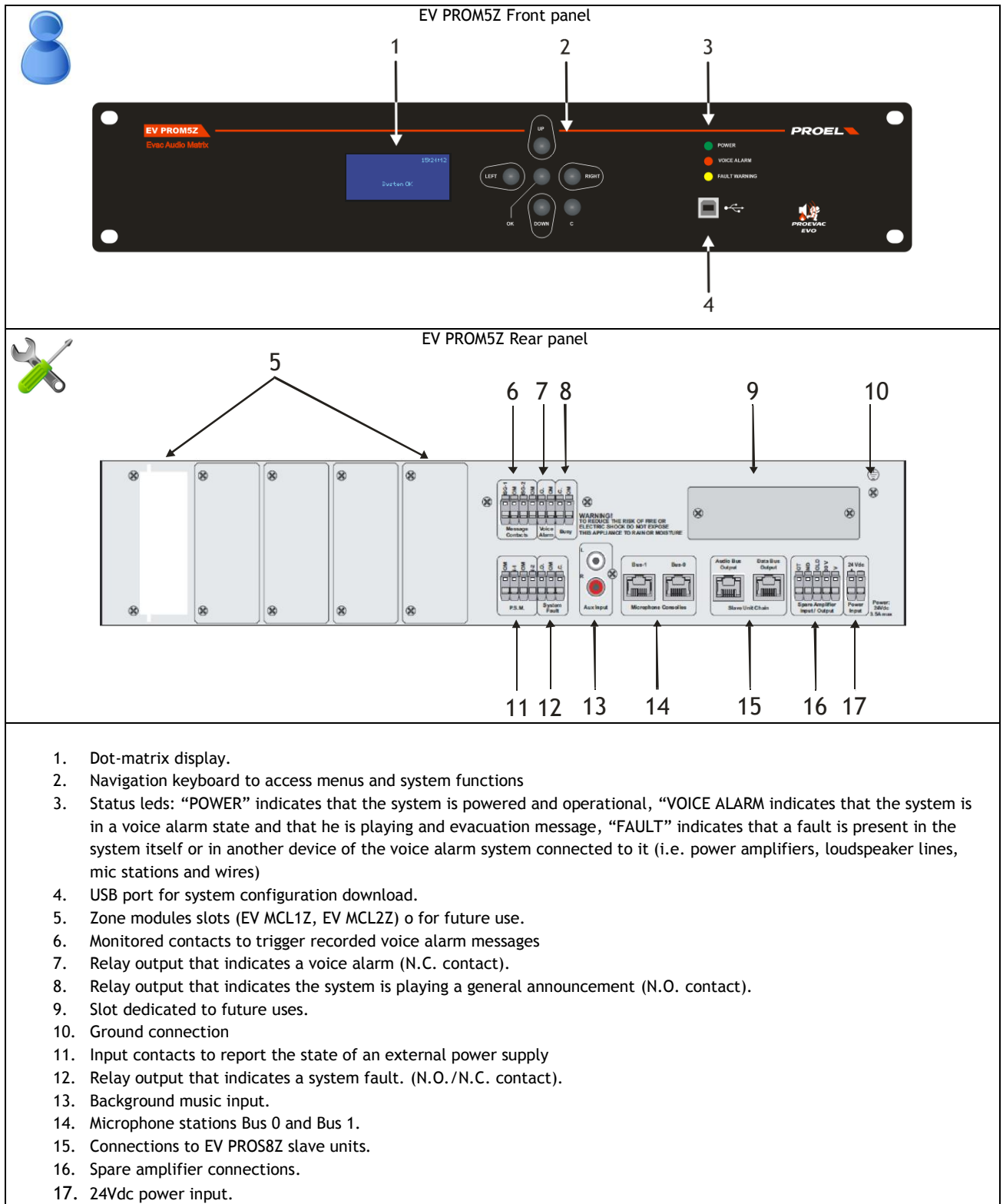

### 3.2 EV PROS8Z Slave unit



WG -ESU08 Front panel





EV PROS8Z Rear Panel



1. Status leds: "POWER" indicates that the unit is powered and operational, "FAULT" indicates that a fault is present in the system itself or in another device of the voice alarm system connected to it (i.e. power amplifiers, loudspeaker lines, mic stations and wires)
2. Zone modules slots (EV MCL1Z, EV MCL2Z) o for future use.
3. Ground connection
4. Chain connections from EV PROM5Z master and to other EV PROS8Z slave units
5. Spare amplifier connections.
6. 24Vdc power input.

### 3.3 Line controller module (line A) EV MCL1Z



1. LED "BUSY": indicates the zone is playing and audio content
2. LED "FAULT": indicates a fault related to the loudspeaker line.
3. Monitored input contacts to trigger alarm messages.
4. Balanced audio output to the power amplifier
5. 100V power input (connect to power amplifier output)
6. 100V loudspeaker line output



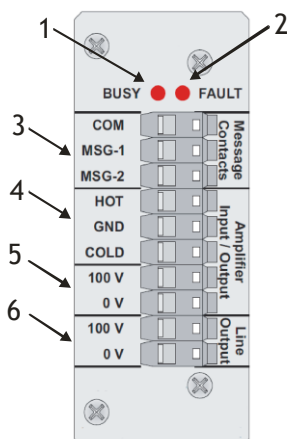

EV MCL1Z connections

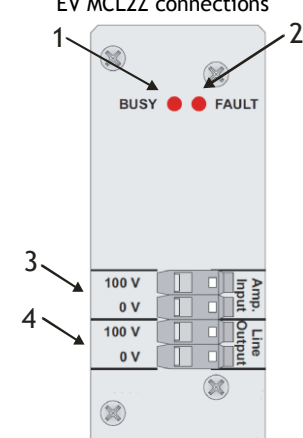

### 3.4 Line controller module (line B) EV MCL2Z

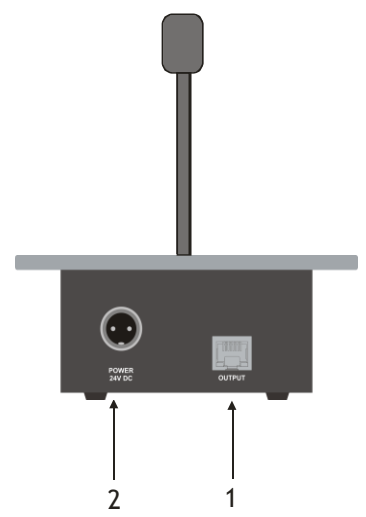
 <ol style="list-style-type: none"> <li>1. LED "BUSY": indicates the zone is playing and audio content</li> <li>2. LED "FAULT": indicates a fault related to the loudspeaker line.</li> <li>3. 100V power input (connect to power amplifier output).</li> <li>4. 100V loudspeaker line output</li> </ol>	<p>EV MCL2Z connections</p>  <p>The diagram shows the rear panel of the EV MCL2Z module. At the top, there are two LEDs labeled 'BUSY' and 'FAULT', each with a red dot. Below them are two sets of terminals. The first set is labeled '100 V' and '0 V' and is connected to 'Input'. The second set is also labeled '100 V' and '0 V' and is connected to 'Output'. Arrows point from the numbers 1, 2, 3, and 4 in the text to the corresponding components in the diagram.</p>
---	---

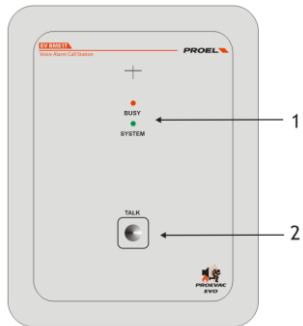
### 3.5 Microphone stations

 <ol style="list-style-type: none"> <li>1. Audio, power and data bus. Connect to dedicated ports on EV PROM5Z</li> <li>2. Auxiliary power input</li> </ol>	<p>Microphone stations rear panel view- all models</p>  <p>The diagram shows the rear panel of a microphone station. It features a circular port labeled 'POWER 5V DC' and a rectangular port labeled 'OUTPUT'. Arrows point from the numbers 2 and 1 in the text to these respective ports.</p>
 <ol style="list-style-type: none"> <li>1. Status leds indicate the status of the system</li> <li>2. "TALK" pushbutton engages the bus and the loudspeaker lines to forward the audio content.</li> </ol>	<p>EV BME1T top panel view</p>  <p>The diagram shows the top panel of the EV BME1T microphone station. It features a red LED labeled 'BUSY SYSTEM' and a circular pushbutton labeled 'TALK'. Arrows point from the numbers 1 and 2 in the text to these components.</p>
	<p>EV BME6T</p>

1. Status leds indicate the status of the system
2. "TALK" pushbutton engages the bus and the loudspeaker lines to forward the audio content previously selected with 3) keys.
3. Zone selection keys on which the microphone channel is opened. The keys are assigned to the zones (or groups) through a configuration in the BEST software. The led close to each key indicates the zone or group is selected.

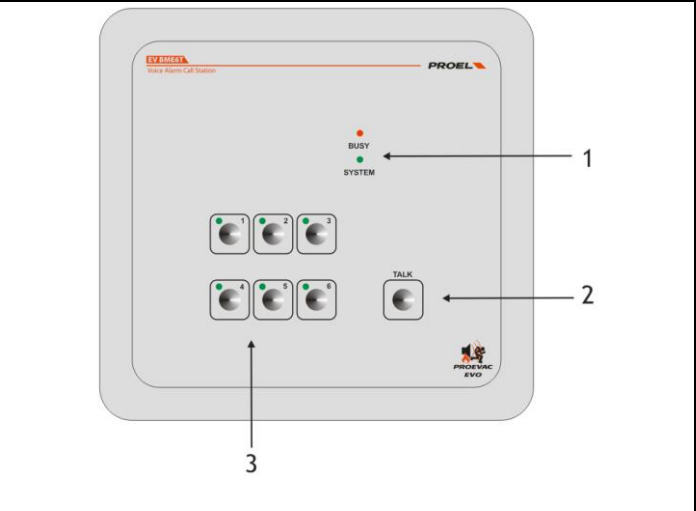

- 
1. Status leds indicate the status of the system
  2. Quick selection keys of pre-recorded messages. The led close to each key indicates message is selected
  3. Dot matrix display
  4. "TALK" pushbutton engages the bus and the loudspeaker lines to forward the audio content previously selected with 5) or 2) keys.
  5. Zone selection keys on which the microphone channel is opened. The keys are assigned to the zones (or groups) through a configuration in the BEST software.
  6. Clear selection key
  7. Background music volume control enablement. Volume may be changed with UP and DOWN keys.

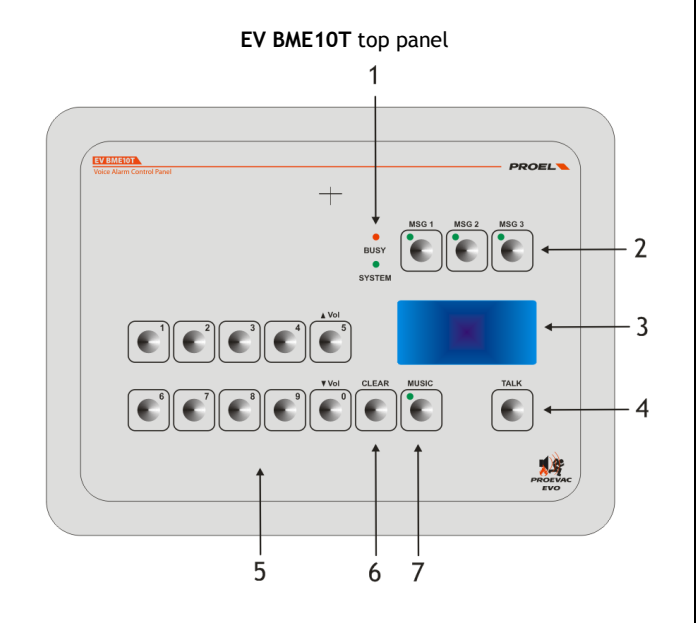

- 
1. Microphone gain trimmer
  2. Address selections and data line termination dip-switch

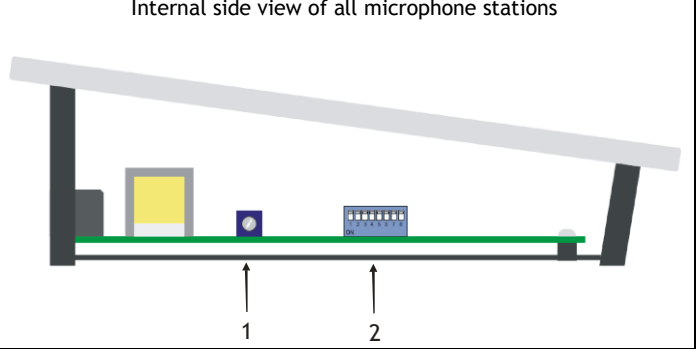

#### 4. DESCRIPTION OF CONNECTIONS AND SYSTEM ASSEMBLY



*This entire section is dedicated to installer/maintainer only*

##### 4.1 Power supply connection

The EV PROM5Z master and EV PROS8Z slaves (if present) must be powered by a 24dv power source coming from an certified EN54-4 power supply and according to the diagram here below. The sizing of the 24dc line shall take into account the current absorption of master, slave unit, microphone stations and zone modules. Please refer to the technical specifications section for these details. Power amplifiers shall be also powered by, or shall integrate, an EN54-4 power supply.

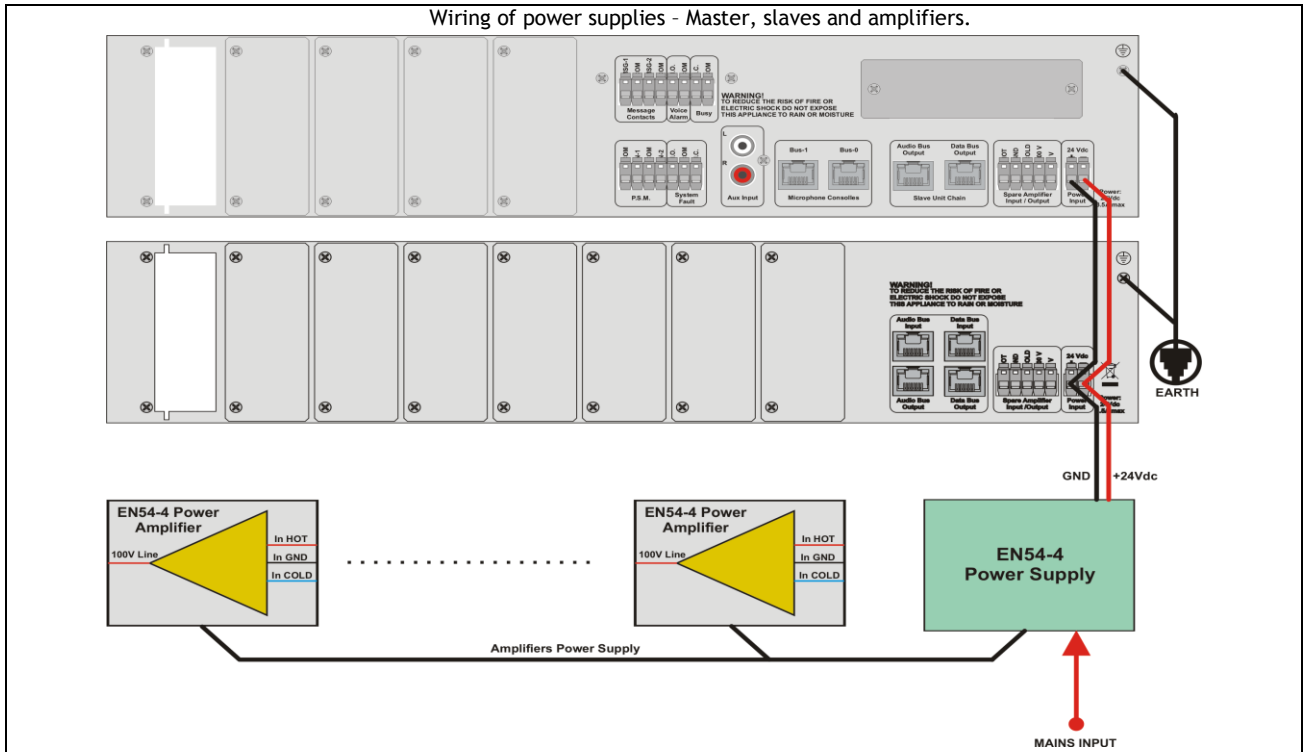

The figure above show explicitly the positive and negative connection of the power line that feeds the Provac system. The power supply line to the amplifies is shown schematically. Please refer to the manuals of power amplifiers and power supply.

Provac requires a ground connection between the Master (and slaves of present) and the chassis of the rack cabinet where the system is installed. The rack cabinet must be connected to a strong earth connection of the building.



It is recommended to periodically check the earth connection with appropriated instruments in order not to affect the performance of the system.



Provac's electrical ground (negative pole of system power) is connected to the chassis.

#### 4.2 Installation of the line modules inside the Master EV PROM5Z and Slave EV PROS8Z units

The Master unit has five vertical slots on the back to be fitted with EV MCL1Z and/or EV MCL2Z line controllers. It is essential that the slots are filled, starting from the left, in the order shown on the figure below. The figure also shows a valid and a not allowed configuration.

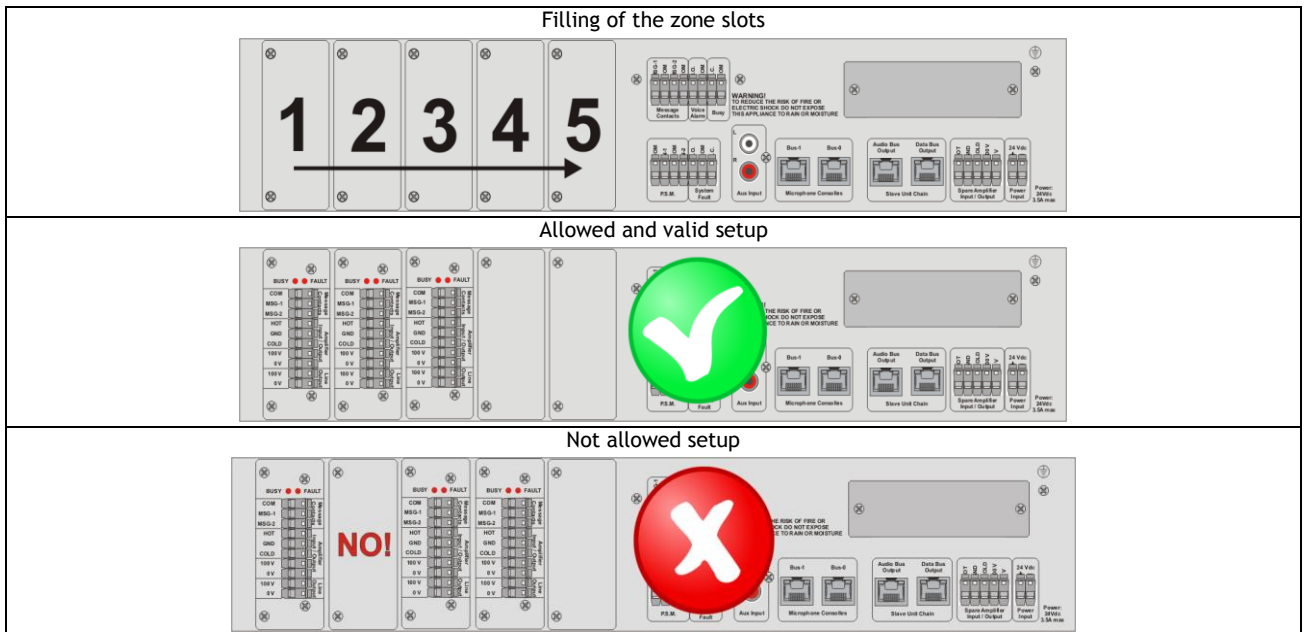

The Slave unit has eight vertical slots on the back to be fitted with EV MCL1Z and/or EV MCL2Z line controllers. It is essential that the slots are filled, starting from the left, in the order shown on the figure below. The figure also shows a valid and a not allowed configuration.

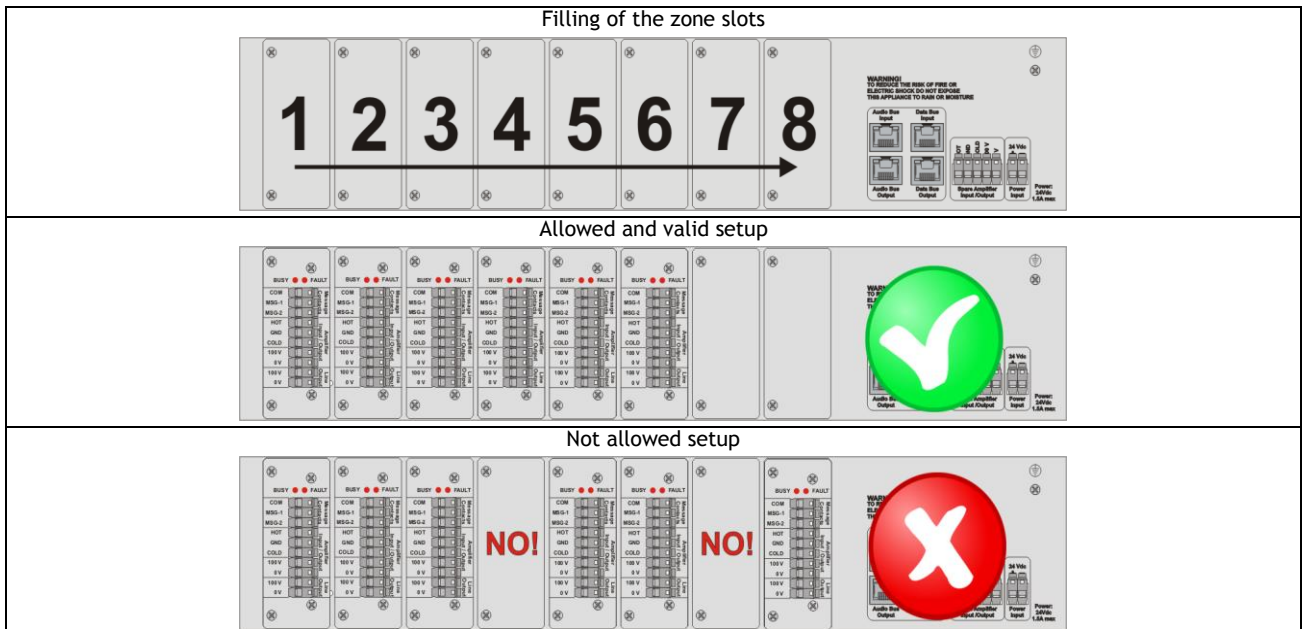

In case you configure a system with a master and one or more slave units, it is not mandatory that the units have all slots loaded. It is possible and allowed to partially load the master and continue the installation of other line modules inside the first slave, that on its turn may not be entirely filled and thus additional modules may be fitted in the second slave, etc... A unit (master or slave) may be even left empty! This gives the system a great configuration flexibility in terms of distribution of the risk of a failure of a loudspeaker line or power amplifier. To best illustrate this feature, please refer to the following application note where a 8 zones system setup is analyzed.



## APPLICATION NOTE - 8 ZONES SYSTEM

An 8 zones system (with lines A only) is a significant case of study since it is possible to configure Proevac in different ways according to the requirements of the voice alarm equipment for a specific building. The requirements may be in favor of the best effort in case of a failure, or look after the best cost/performance ratio. Balancing the risk of a failure for the Proevac system in this application note, goes through an assessment of the possibility of a fault of one of the main power amplifiers. As mentioned previously, the master and slave units have the possibility to manage a spare amplifier that will switch over in case of a failure to the main power amplifier managed by one of the line modules fitted in the unit. Proevac has the flexibility to optimize the setup in order to achieve the best compromise in terms of cost effectiveness and risk, or at the extremes, it is possible to configure the system for a maximum economy (with one or no spare amplifiers), or for a minimum risk with a spare amplifier for each zone, but at a higher cost.

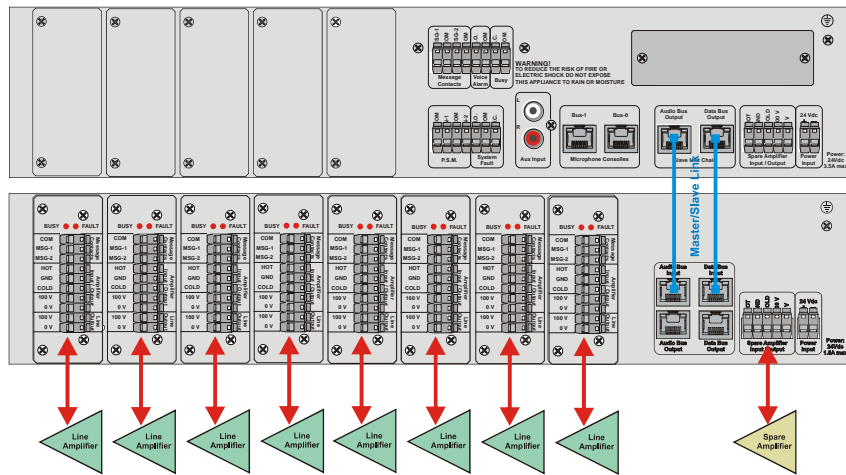

The figure here on the left, describes an 8 zones, low budget system, but at the expense of a higher risk. In fact, it is foreseen only one spare amplifier (yellow) that will switch over the first of the eight main amplifiers that will fail. If a second main amplifier will fail, no spare amplifier will be available since it is already in use.

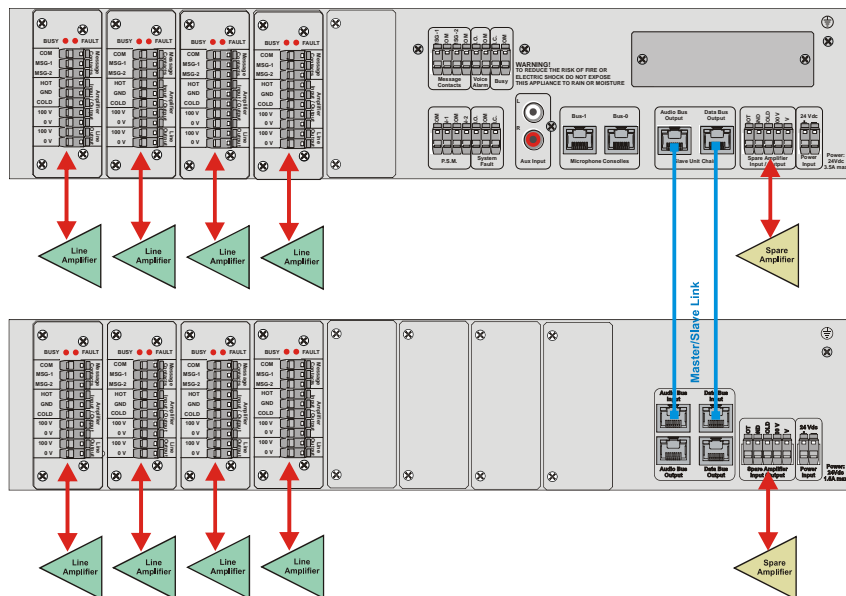

The figure here on the left, describes an 8 zones system where a good balance between risk and cost is achieved thanks to two spare amplifiers. Four zone modules are fitted in the master and four in the slave. Each group of four is served by a spare amplifier.

Continuing with this logic, it is possible to furtherly distribute the risk by setting up the same 8 zones with one master, three slaves, with two zone modules each and four spare amplifiers. Each spare amplifier will eventually serve just two zones:

- Master EV PROM5Z + 2x EV MCL1Z modules + spare amplifier
- Slave EV PROS8Z + 2x EV MCL1Z modules + spare amplifier
- Slave EV PROS8Z + 2x EV MCL1Z modules + spare amplifier
- Slave EV PROS8Z + 2x EV MCL1Z modules + spare amplifier



In case we want to minimize the risk of rupture of the main amplifiers by providing one spare for each main amplifier, the system should be setup with one master, seven slaves each fitted with one zone controller and a spare amplifier:

- Master EV PROM5Z + 1x EV MCL1Z module + spare amplifier
- Slave EV PROS8Z + 1x EV MCL1Z module + spare amplifier
- Slave EV PROS8Z + 1x EV MCL1Z module + spare amplifier
- Slave EV PROS8Z + 1x EV MCL1Z module + spare amplifier
- Slave EV PROS8Z + 1x EV MCL1Z module + spare amplifier
- Slave EV PROS8Z + 1x EV MCL1Z module + spare amplifier
- Slave EV PROS8Z + 1x EV MCL1Z module + spare amplifier
- Slave EV PROS8Z + 1x EV MCL1Z module + spare amplifier

Mixed solutions are also implementable.

In case it is believed that 2 zones are at high risk and 6 zones at low risk, the 8 zones system may be setup as follows

- Master EV PROM5Z + 2x EV MCL1Z modules + spare amplifier
- Slave EV PROS8Z + 6x EV MCL1Z modules + spare amplifier

In case one zone is at high risk, 4 zones at “medium” risk and 3 at lower risk:

- Master EV PROM5Z + 1x EV MCL1Z modules + spare amplifier
- Slave EV PROS8Z + 2x EV MCL1Z modules + spare amplifier
- Slave EV PROS8Z + 2x EV MCL1Z modules + spare amplifier
- Slave EV PROS8Z + 3x EV MCL1Z modules + spare amplifier

If the voice alarm system specifications require the redundancy of one more loudspeaker lines (Line A+B) powered by the same amplifier, the EV MCL2Z will be matched to the main zone controller and the master and slave units will be filled according the logic explained above and the indications found in section 4.6.

Here an example of a 8 zone system with 5 line A only zones and 3 zones with line A+B and two spare amplifiers:

- Master EV PROM5Z + 2x EV MCL1Z modules + 1x line B EV MCL2Z modules + spare amplifier
- Slave EV PROS8Z + 6x EV MCL1Z modules + 2x line B EV MCL2Z modules + spare amplifier

The installation of the modules inside the master and slave unit is very simple but requires some care when plugging the module in the internal mainboard.

Remove the slot cover by unscrewing the screws pointed by the yellow arrows.

Slide the circuit of the module inside the dents pointed by the red arrows, then delicately push the module until the frame sets on the unit's back panel. Secure the module with the screws that were previously removed.

Installing the zone modules inside Master and Slave units

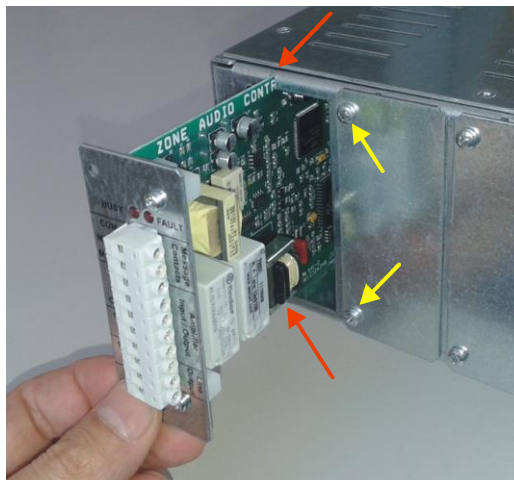

**WARNING!!** Do not force for any reason the unit inside the slot! Forcing the module may seriously damage the bus connector inside the unit!

### 4.3 Connection of the EV PROM5Z master unit to one or more EV PROS8Z slaves

The wiring between the master and slave units achieved through the pairs of a UTP CAT 5 cable, pin-to-pin wired on RJ45 plugs and without crossing Audio-Link and Data-Link on connection between the units.

The EV PROM5Z master unit can handle up to 13 slaves with a total of 108 zones.

The cable lengths is so specified:

- Cable between one unit and another: max 5,0 meters
- Cable between the master and the last slave in the chain: max 20,0 meters

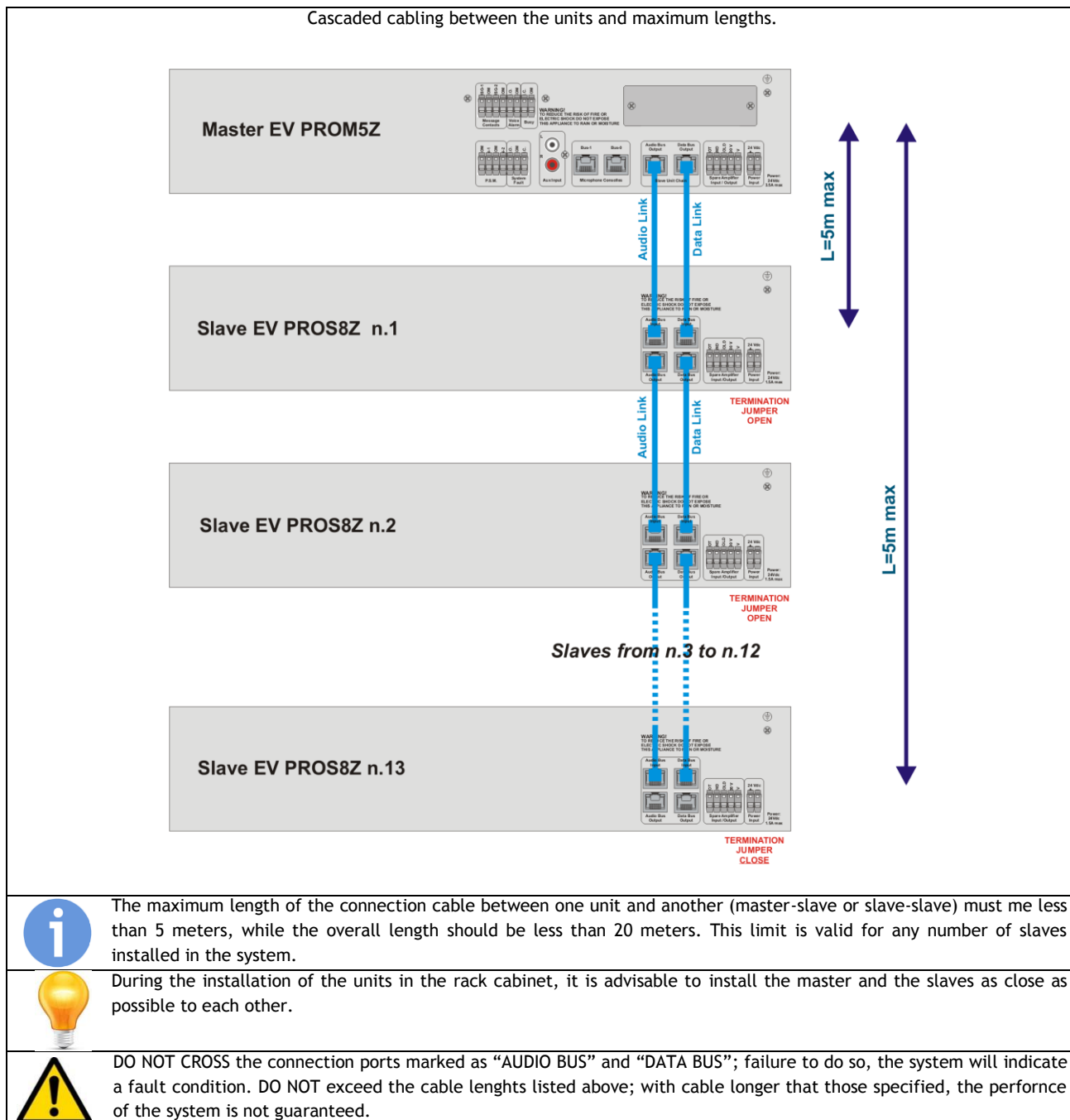



The Slave units will require to close a line termination on the data bus to allow a proper communication.

The EV PROS8Z slave units is delivered from the factory with the jumper OPEN.

It is required to close the jumper on the last slave unit of the chain, or in other words, the most “distant” from the master, when:

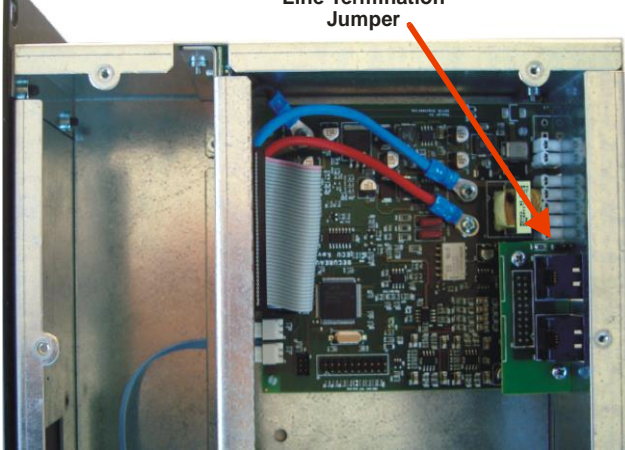
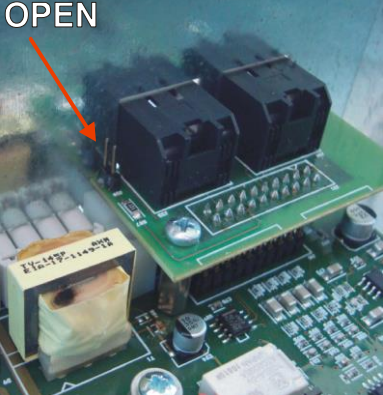
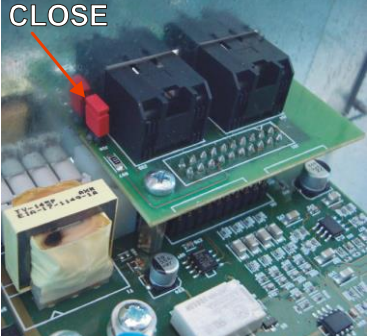
- The system had two or more slave units
- The last slave unit has a link cable to the master that is longer than 1 meter; this statement is true also when just one slave unit is present in the chain.

 <p>Line Termination Jumper</p> <p>The image shows the internal components of a slave unit with a red arrow pointing to a specific component on the daughter board.</p>	<p>Jumper identification</p> <p>The jumper is located on the daughter board inside the slave unit. The top cover should be removed to access the jumper.</p>
 <p>OPEN</p> <p>The image shows the jumper in an open position, with a red arrow pointing to the gap between the contacts.</p>	<p>Termination OPEN</p>
 <p>CLOSE</p> <p>The image shows the jumper in a closed position, with a red arrow pointing to the bridge connecting the contacts.</p>	<p>Termination CLOSED</p> <p>The jumper should be closed on the last slave of the chain when the system has two or more slaves and /or when the cable length is longer than 1m.</p>
 <p>If the rules described herein are not strictly followed, the performance of the system is not guaranteed. In such case, the system may report a fault condition.</p>	

#### 4.4 Spare amplifier wiring on EV PROM5Z master and EV PROS8Z slave unit.

If a spare amplifier is used, it shall be connected to the plug on the back-panel labelled “Spare Amplifier Input/Output”. Please refer to section 3.1 and section 3.2 for proper identification. The connection scheme in the figure below is the same for both master and slave unit. The plugs labelled “HOT-GND-COLD” are the outputs to the amplifier. The plugs labelled “0V-100V” refer to the power amplifier output. The output of the amplifier is connected back to the unit that routes it to the loudspeakers.

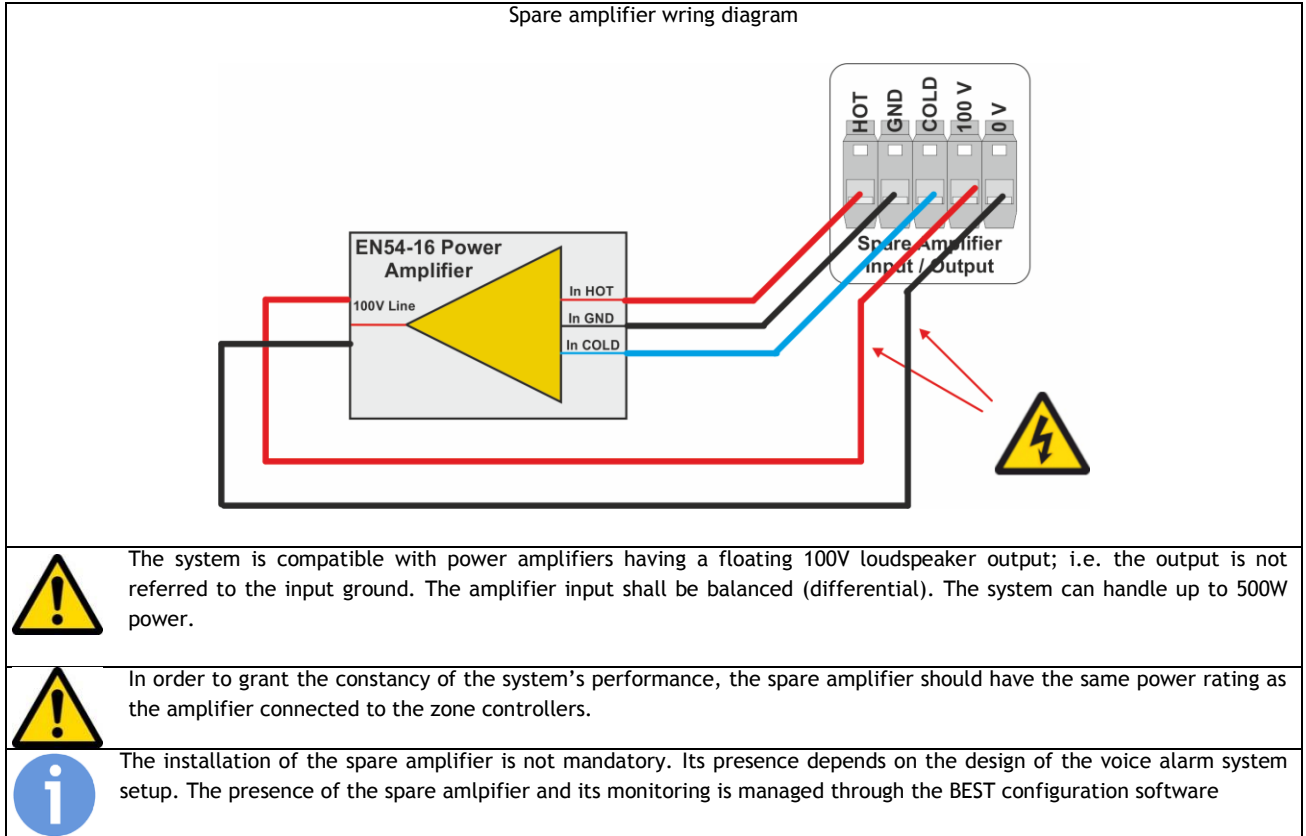

#### 4.5 Wiring the EV MCL1Z line modules.

The EV MCL1Z manages all line functions, it routes the audio programs and messages, performs the monitoring of the loudspeakers lines and power amplifier. Additionally, its onboard player, feeds the line with dedicated alarm messages.

The activations of the alarm messages is performed through the dedicated monitored contacts. The enablement and assignment of such messages is performed through the BEST configuration software.

The figure here below shows the wiring of the line module to the power amplifier, loudspeaker line and message triggers.

The “HOT-GND-COLD” are the balanced outputs to the power amplifier. This output is transformer coupled and is isolated from the main system ground.

The “0V-100V” plugs in the “Amplifier Input/Output” section refer to the output of the power amplifier that will feed the speakers. This is connected back to the line module for power routing and monitoring.

The plugs labelled “0V-100V” in the “Line Output” section refer to the connection to the loudspeaker line inside the facility.

“MSG-1” and “MSG-2” plugs are the recorded alarm message triggers. Both refer to the “Common” plug. These inputs implement a continuous monitoring against cable short and cable cut. This function is achieved through the two 2.2Kohm resistors that should be connected as shown in the figure. The switch symbol refers to the contact inside the fire alarm unit that triggers the message.

Wiring scheme of the EV MCL1Z line module

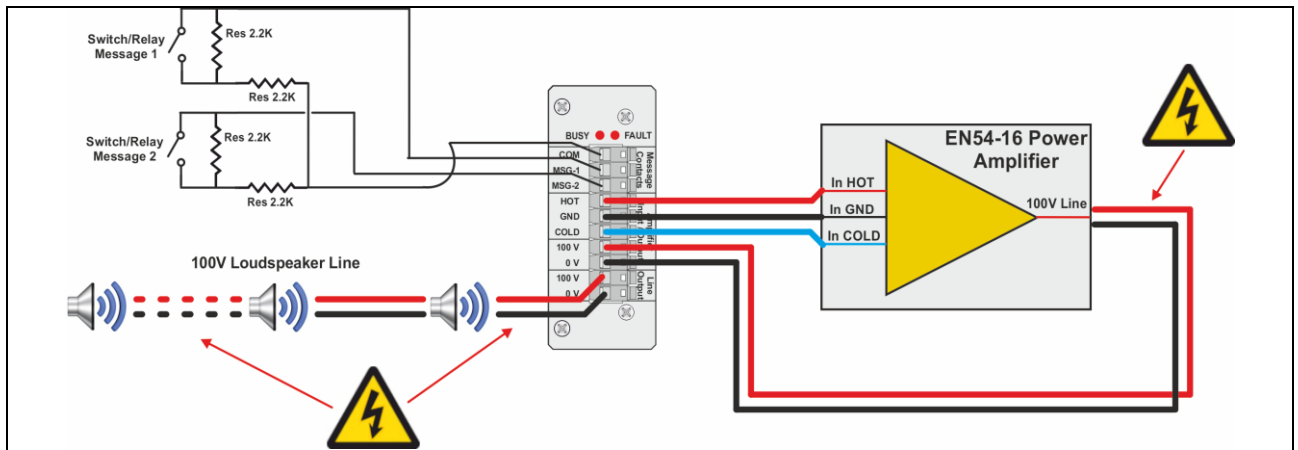

The system is compatible with power amplifiers having a floating 100V loudspeaker output; i.e. the output is not referred to the input ground. The amplifier input shall be balanced (differential). The system can handle up to 500W power.



The line module can monitor loads starting from approximately 30W. The term “approximately” is appropriated since, during the calibration process, the module will first drive the power amplifier so that its output is 100V on the loudspeakers line, then it will measure the load impedance and the nominal power absorbed by the load at 1KHz and at 18KHz so that all other measurements will not be hearable by the residents in the building. At 18KHz the measured impedance and power may be slightly different than at 1KHz since two phenomena occur: the gain attenuation of the amplifier and the impedance of the loudspeakers will be surely higher than at 1KHz, according to the curve specified by the manufacturer. Therefore, those cases where the matching of an amplifier with an extended frequency range to loudspeakers with a flat impedance module, will allow the module to measure accurately even less than 5W. On the other hand, if the power amplifier has a narrower response on higher frequencies, and loudspeakers impedance module increase on the same frequencies, it will be harder for the line module to perform a consistent measurement on lower loads.



When designing the system setup and loudspeaker line, the engineer shall select an amplifier with sufficient power to drive the loudspeaker line. It is advisable to keep some safety margin so that the load applied to the amplifier is about 85-90% of the maximum deliverable power.



One of the procedures that are discussed in this manual is about the calibration of the loudspeaker lines; such calibration is performed at access level 2 or 3. During this automatic procedure, the system will verify that the amplifier is effectively able to drive the loudspeaker and that the amplifier is not overloaded. This particular feature will allow, during the commissioning of the system, to check that the dimensioning and installation of the loudspeakers is coherent with the installed power amplifier. The system itself will perform as a test instrument to validate the entire setup without any impedance meter.

The calibration procedure is also used by the system to acquire the initial parameters that will be used as a reference for all other line and amplifier measurements and checks.



The 2.2Kohm resistors on the triggers for the recorded line messages shall be placed close to the fire alarm equipment in order to effectively monitor the cable against cuts and shorts.



If the setup of the system does not require any input to trigger the recorded messages, the contacts shall be left open.

#### 4.6 Wiring the EV MCL2Z Line B module

The EV MCL2Z module allows to configure a system with two redundant loudspeaker lines (line A + B) fed by the same power amplifier, thus keeping the independency of the load's parameters monitoring (impedance and absorbed power). Functionally, the EV MCL1Z module will manage the power amplifier, will perform the monitoring of the main amplifier, of the loudspeaker line A and will read the state of the input contacts that will trigger the alarm messages on the zone. The EV MCL2Z on its side, will perform the line B monitoring. Both lines A and B are powered by the same amplifier.

When assembling the master and slave units, it is mandatory to install the EV MCL2Z line B module on the right of the EV MCL1Z main line module. Doing so, the system will automatically recognize the combination of the line A and line B modules. This is the only obligation in the assembly of the line modules A and B inside the master and slave units, still remaining valid all statements illustrated in section 4.2

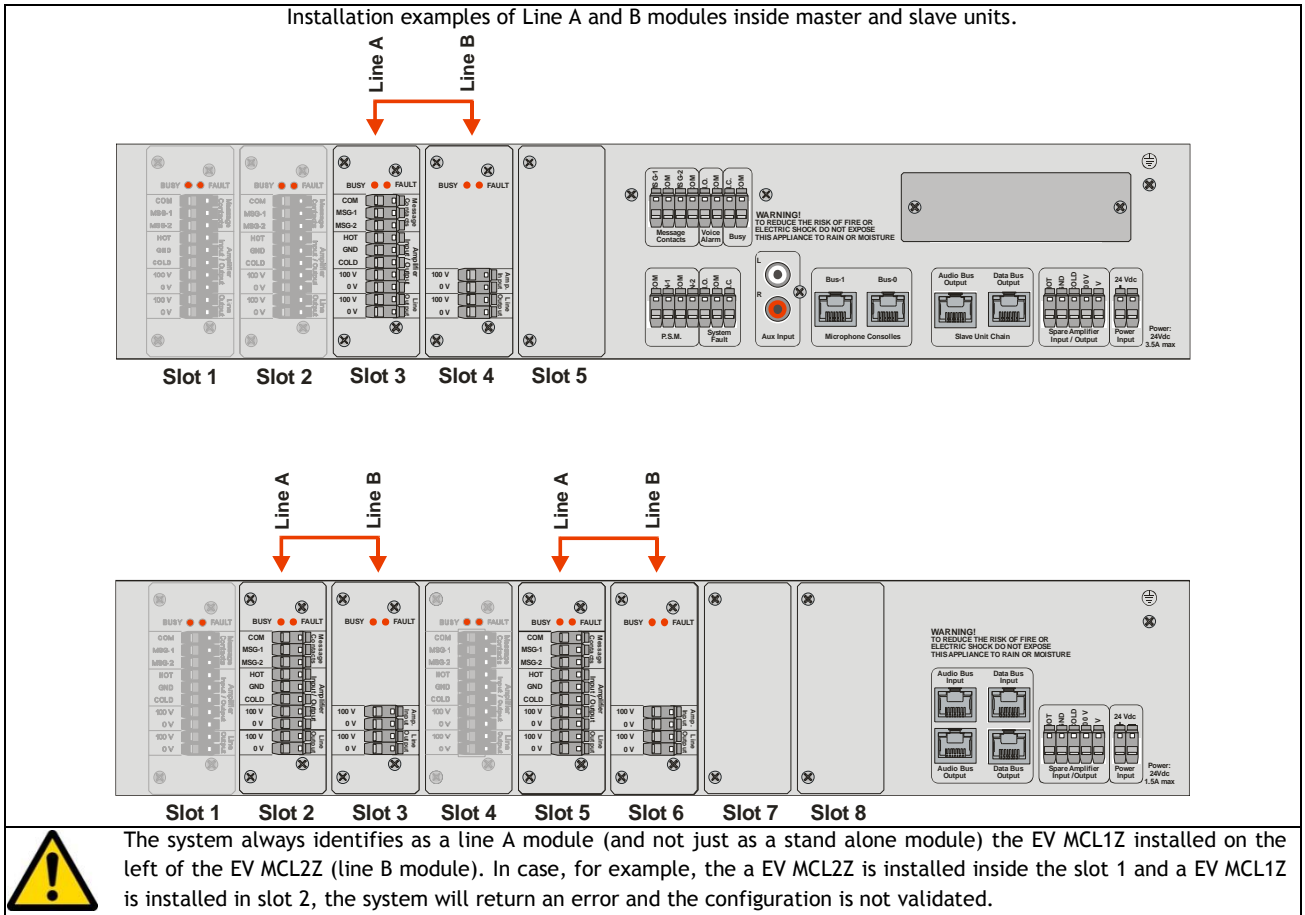



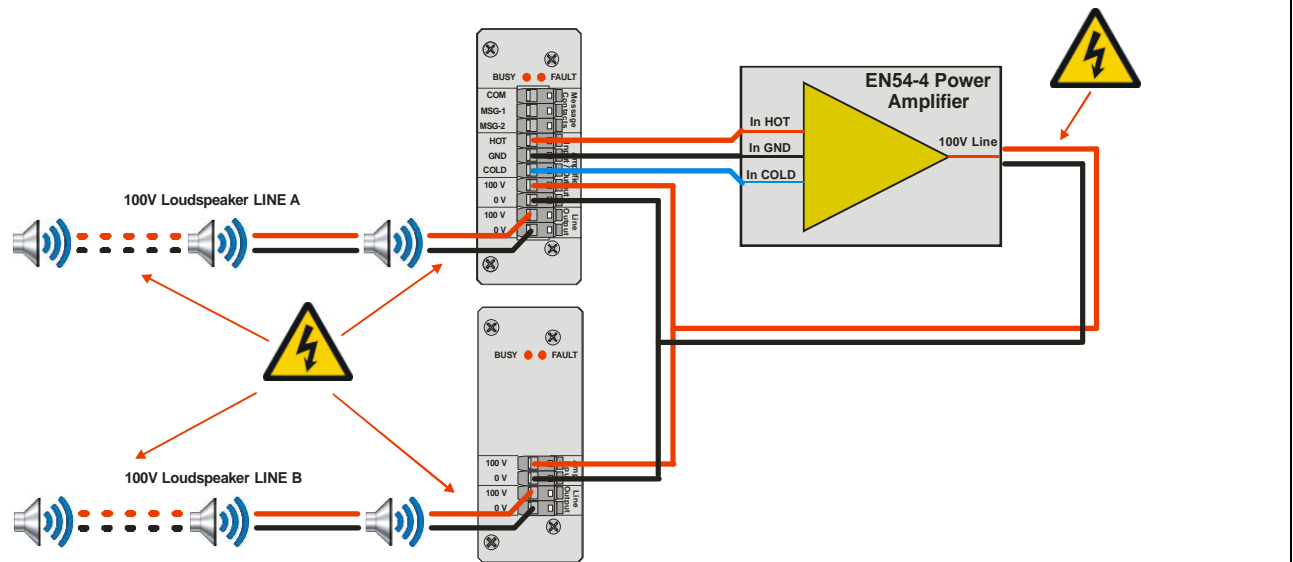

When configuring the system for a Line A and line B zone, the installer must wire the EV MCL1Z and EV MCL2Z according to the figure below. The 100V output of the amplifier has to be tied to both modules, so that each of them shall perform the monitoring of the loudspeaker line connected to it. The connection of the dry contacts that will trigger the recorded alarm messages is described in section 4.5

Connection diagram of the EV MCL1Z and EV MCL2Z in a Line A+B setup.





 The EV MCL2Z line B module is compatible with power amplifiers having a floating 100V loudspeaker output; i.e. the output is not referred to the input ground. The module can handle up to 500W power.

 The pair EV MCL1Z and EV MCL2Z is capable of monitoring loads of the loudspeaker line approximately no less than 50W per line.  
 The term “approximately” is appropriated since, during the initial calibration, the module will first drive the power amplifier so that its output is 100V on the loudspeakers line, then it will measure the load impedance and the nominal power absorbed by the load at 1KHz and at 18KHz so that all other measurements will not be hearable by the residents in the building. At 18Khz the measured impedance and power may be slightly different at 1Khz since two phenomena occur: the gain attenuation of the amplifier and the impedance of the loudspeakers that will be surely be higher than at 1Khz, according to the curve specified by the manufacturer.  
 Therefore, those cases where the matching of an amplifier with an extended frequency range to loudspeakers with a flat impedance module, will allow the module to measure accurately even less than 10W. On the other hand, if the power amplifier has a narrower response on higher frequencies and loudspeakers impedance module increase on the same frequencies, it will be harder for the line module to perform a consistent measurement on lower loads.

 When designing the system setup and loudspeaker line, the engineer shall select an amplifier with sufficient power to drive the loudspeaker line. It is advisable to keep some safety margin so that the load applied to the amplifier is about 85-90% of the maximum deliverable power.

 One of the procedures that are discussed in this manual is about the calibration of the loudspeaker lines; such calibration is performed ad access level 2 or 3. During this automatic procedure, the system will verify that the amplifier is effectively able to drive the loudspeaker and that the amplifier is not overloaded. This particular feature will allow, during the commissioning of the system, to check that the dimensioning and installation of the loudspeakers is coherent with the installed power amplifier. The system itself will perform as a test instrument to validate the entire setup without any impedance meter.  
 The calibration procedure is also used by the system to acquire the initial parameters that will be used as a reference for all other line and amplifier measurements and checks.

 In a Line A+B setup, in case of a failure in one of the two lines, Proevac will isolate the faulty line in order to protect the power amplifier and will increase the audio volume on the line that remains active in order to grant the same sound pressure inside the zone of the building. The amount of the volume increase is set through the BEST configuration software.

 In a Line A+B setup, if a loudspeaker line should fail, the system will isolate the faulty line and will increase the audio volume on the other line. Care must be taken in dimensioning the loudspeaker line so that the loudspeakers are effectively able to absorb the increase of power without damage.

## 4.7 Wiring and configuring the microphone stations

Proevac has two separate and independent busses dedicated to the microphone stations.

Each bus can accommodate up to 54 stations for a total of 108. The functions of the microphone stations, the assignments to the zones or groups and related broadcasting rules, are configured via software to BEST. When configuring a microphone station, the installer can decide to assign it as a fire emergency call station, or as general purpose announcement unit. In case a microphone station is configured as a fire alarm call station, Proevac will perform a continuous monitoring of all audio path, from the microphone capsule up to all connections to the master unit, as prescribed by EN54-16 specifications.

This section discusses the connection of microphone stations to the master unit and the wiring of the bus inside the building. All that will be discussed hereafter is common to all microphone stations models. For the use and activation of the features supported by the single model, please refer to the appropriate section in this manual and to the configuration box of the BEST software.

Each of the two microphone busses are identified in the figure found in section 4.1. The two ports accommodate an RJ45 Cat 5 plug. The same connector is found on the microphone stations. The installer shall implement a 1-to-1 connection between the RJ45 plugs from the master to the microphone stations.

The figure here below shows the numbering of the wires to be fitted in the RJ45 connector; the installer should connect all 8 wires.

Microphone stations RJ45 pin identification.

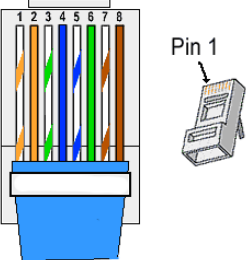





All pins on the RJ45 connectors should be wired 1-to-1. If some pins are crossed, the bus will not operate and the system will return an error.

The microphone stations connection bus should have a linear arrangement with all stations connected in parallel, starting from the closest station to the master and ending with the last station in the chain. A star arrangement of the bus is not allowed and may lead to a non correct operation and poor performance.

Short stubs from the main bus to the stations are allowed, but the following maximum lengths should be taken in to account:

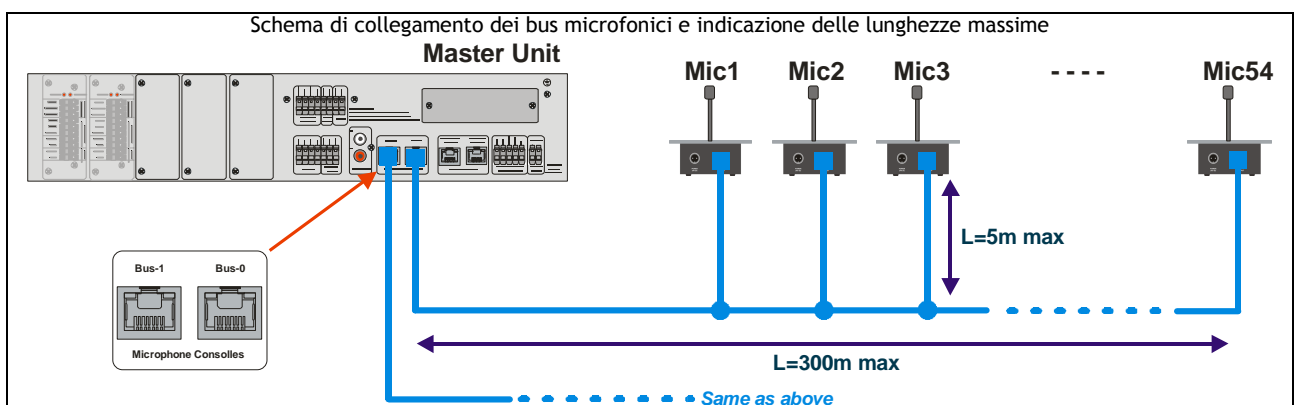
- Max cable length, from the master to the last microphone station: 300m
- Max length of each stub: 5m



 For clarity's sake, the figura above illustates the connection of a maximum of 54 stations on the upper bus. It is clear that the same structure can be replicated on the dashed bus in the lower part part of the figure with other 54 stations.

 The correct operation is not granted in case of a star bus, or mixed star-linear bus configurations and with overall cable lengths higher that specified.

 The microphone stations have a port on the rear panel for an auxiliary power supply. Although the master unit is supplying power to all stations, there may be situations where it is needed to feed one or more microphone stations through an external power supply. This will depend on the overall cable length and on the number of stations hanged to the bus.

Inside the microphone stations, there is a jumper that raises the power supply from the bus. If the jumper is opened,



this the call station will not be powered from the bus and a local power supply is needed.  
 A microphone stations should be powered locally in case:

- 15 or more stations are connected to the bus. All stations after the tenth should be powered by their own mains adapter
- The bus cable length is higher than 100 meters. In this case, microphone stations located more than 100 meters away from the master should be powered by their own mains adapter.



It is advisable to locate the microphone stations configurad as fire alarm call stations the close as possible to the master unit.  
 It is not advosable to power externally the microphone stations configured as alarm call stations since these are subject to a continuous monitoring from the master unit; If powered externally and in case the mains adapter is disconnected, the master unit will return a fault warning.

Once the system is cabled inside the building, it is necessary to configure all microphone stations and set the bus address, insert the line termination and set the gain of the microphone. The figures here below describe the configuration process.

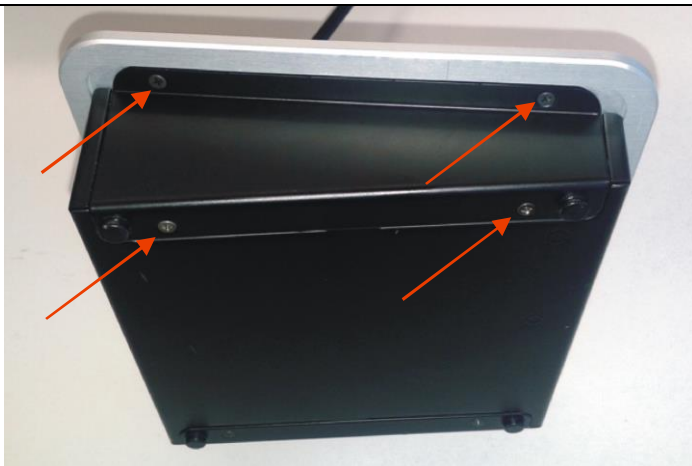

Remove the screws pointed by the red arrows.

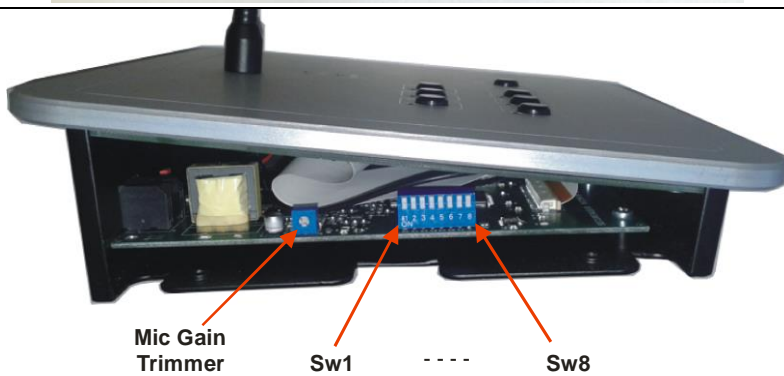

Set dip switches according to the table here below.

Connect the microphone station to the system and set the microphone gain.

The table here below shows the dip-switch configuration according to the assigned bus ID of the microphone station. The bus ID must be set accordingly to the configuration designed on the BEST software.

**WARNING: identical IDs are not allowed on the same bus.**

ID	SW1	SW2	SW3	SW4	SW5	SW6
1	ON	Off	Off	Off	Off	Off
2	Off	ON	Off	Off	Off	Off
3	ON	ON	Off	Off	Off	Off
4	Off	Off	ON	Off	Off	Off
5	ON	Off	ON	Off	Off	Off
6	Off	ON	ON	Off	Off	Off
7	ON	ON	ON	Off	Off	Off
8	Off	Off	Off	ON	Off	Off
9	ON	Off	Off	ON	Off	Off
10	Off	ON	Off	ON	Off	Off
11	ON	ON	Off	ON	Off	Off
12	Off	Off	ON	ON	Off	Off
13	ON	Off	ON	ON	Off	Off
14	Off	ON	ON	ON	Off	Off
15	ON	ON	ON	ON	Off	Off
16	Off	Off	Off	Off	ON	Off
17	ON	Off	Off	Off	ON	Off
18	Off	ON	Off	Off	ON	Off
19	ON	ON	Off	Off	ON	Off
20	Off	Off	ON	Off	ON	Off
21	ON	Off	ON	Off	ON	Off
22	Off	ON	ON	Off	ON	Off
23	ON	ON	ON	Off	ON	Off
24	Off	Off	Off	ON	ON	Off
25	ON	Off	Off	ON	ON	Off
26	Off	ON	Off	ON	ON	Off
27	ON	ON	Off	ON	ON	Off
28	Off	Off	ON	ON	ON	Off
29	ON	Off	ON	ON	ON	Off
30	Off	ON	ON	ON	ON	Off
31	ON	ON	ON	ON	ON	Off
32	Off	Off	Off	Off	Off	ON
33	ON	Off	Off	Off	Off	ON
34	Off	ON	Off	Off	Off	ON
35	ON	ON	Off	Off	Off	ON
36	Off	Off	ON	Off	Off	ON
37	ON	Off	ON	Off	Off	ON
38	Off	ON	ON	Off	Off	ON
39	ON	ON	ON	Off	Off	ON
40	Off	Off	Off	ON	Off	ON
41	ON	Off	Off	ON	Off	ON
42	Off	ON	Off	ON	Off	ON
43	ON	ON	Off	ON	Off	ON
44	Off	Off	ON	ON	Off	ON
45	ON	Off	ON	ON	Off	ON
46	Off	ON	ON	ON	Off	ON
47	ON	ON	ON	ON	Off	ON
48	Off	Off	Off	Off	ON	ON
49	ON	Off	Off	Off	ON	ON
50	Off	ON	Off	Off	ON	ON
51	ON	ON	Off	Off	ON	ON
52	Off	Off	ON	Off	ON	ON
53	ON	Off	ON	Off	ON	ON
54	Off	ON	ON	Off	ON	ON

Dip Switch n. 7 selects on which bus, 0 or 1, the microphone station is assigned in the BEST project. Set the switch position accordingly.

**WARNING:** A bus assignment that is not coherent to the connection of the microphone station to the master unit, will return a fault warning.

Bus select	SW7
Bus 0	Off
Bus 1	ON

Dip switch n. 8 selects the data-line termination. The line termination switch must be set to ON on the last microphone station connected to the bus, the one that is the most distant from the master unit.

**WARNING:** If the line termination is enabled on microphone stations other than the one on the furthestmost position from the master, a drop of performance of the system may occur and a fault warning may be returned.

Termination	SW8
Bus 0	Off
Bus 1	ON

#### 4.8 Replacing the clock battery

The EV PROM5Z has an internal battery for its system clock. The CR2032 type battery should be replaced once every two years for proper system performance.



To replace the battery, first unpower the system. Remove the top cover of the master unit and locate the battery on the main circuit board.

Remove the old battery from its holder and replace it with a new one. The battery should be oriented with the positive (+) pole face-up.

Once the battery is replaced, the current date and time should be entered; see dedicated procedure.

#### 4.9 uSD Memory card installation

The EV PROM5Z master unit has a uSD memory card on the mainboard. The uSD stores the recorded messages and system configuration. To load the uSD card, you should first insert the card into a PC and download the files through the BEST configuration software.

The following pictures illustrate how to install and remove the uSD from the master unit.

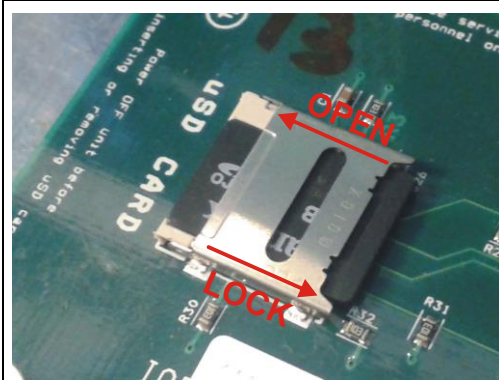

The uSD card socket is located on the main circuit board inside the EV PROM5Z master unit, close to the clock battery. The unit's top cover should be removed.

The uSD socket has a metallic cover on the upper surface. Sliding the cover left or right, the card is locked or unlocked. Please refer to the figure on the left for details.

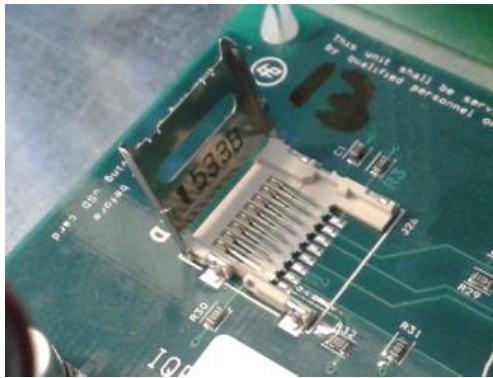

Once the cover is unlocked, the card-holder opens like shown in the figure.

Lay the uSD card on the opened socket as shown close the cover and slide it in the LOCK position.



in the picture, then

#### 4.10 Completing the system

Proevac is certified according to EN54-16 specifications. In order to ensure the conformity of the overall system to the EN54-16 requirements, Proevac should be completed with:

- EN54-4 Power supply
- EN54-16 Power amplifiers
- EN54-24 Loudspeakers
- Fireproof cables

## 5. DESCRIPTION AND IDENTIFICATION OF THE SYSTEM STATUS





Proevac was designed to manage several operational conditions according to the EN54-16 specifications. The current state of the system is displayed by the leds on the master unit, slave units and microphone stations. Additionally the dot-matrix display on the master unit shows all details. Finally, two leds on the zone modules indicate the state of the single zone.

<ul style="list-style-type: none"> <li><input checked="" type="radio"/> POWER</li> <li><input type="radio"/> VOICE ALARM</li> <li><input type="radio"/> FAULT WARNING</li> </ul>	<p><b>QUIESCENT State:</b> This is the idle state where the system belongs when no alarm, no fault conditions and no general announcements are being played. In the idle state, the system only plays the background music applied to the RCA terminals on the master's back panel. When the system is in a quiescent state, only the green led is ON, indicating that the system is powered.</p>
<ul style="list-style-type: none"> <li><input checked="" type="radio"/> POWER</li> <li><input type="radio"/> VOICE ALARM</li> <li><input type="radio"/> FAULT WARNING</li> </ul>	<p><b>BUSY State:</b> This is an operational condition where one or more zones are activated to play general recorded messages or general spoken announcements through a microphone station. According to the purposes of a fire alarm equipment, the BUSY state is compared to the QUIESCENT state, since no fire alarm messages are being played. For this reason, the front panel of the master unit will show just the green led ON.</p>
<ul style="list-style-type: none"> <li><input checked="" type="radio"/> POWER</li> <li><input checked="" type="radio"/> VOICE ALARM</li> <li><input type="radio"/> FAULT WARNING</li> </ul>	<p><b>ALARM State:</b> The system switches to the ALARM state in case a fire alarm announcement is triggered from the dedicated input contacts or spoken through a microphone station configured as a firemen's call stations. In case of a fire alarm, the red led is ON.</p>
<ul style="list-style-type: none"> <li><input checked="" type="radio"/> POWER</li> <li><input type="radio"/> VOICE ALARM</li> <li><input checked="" type="radio"/> FAULT WARNING</li> </ul>	<p><b>FAULT Condition:</b> The fault condition indicates that the diagnostic system has detected at least one failure. The visual indication - yellow led ON - is accompanied by an acoustic signal. If the fault refers to a power amplifier or to a loudspeaker line, the FAULT led on the zone module(s) where the failure was detected will turn ON. The green led will stay ON, indicating the system is powered.</p>

The system status is also visible from the microphone stations, please refer to the dedicated section in this manual for further details.

**NOTE: if both yellow and red leds turn to ON, the system has detected both a fire alarm and a fault condition.**

In addition to the status indications provided by the front panel and rear panel leds, the system reports on the dot-matrix display all details of the status in which it belongs.

		<p><b>QUIESCENT or BUSY status</b></p> <p>The system is idle and is eventually playing background music or general announcements. No faults are detected and no fire alarms are engaged. Eventually, the triangle on the right will flash to indicate that a fault was detected but now is recovered. Please refer to the Logs table for further details.</p>
		<p><b>ALARM status</b></p> <p>The display indicates the list of the zones where a voice alarm has been activated.</p>
		<p><b>FAULT status</b></p> <p>The display indicates the list of the faults that are present. Please refer to Logs table for further details.</p>
		<p><b>FAULT and ALARM status</b></p> <p>The display indicates the list of the faults and voice alarm that are currently present. Please refer to Logs table for further details.</p>

## 6. ACCESSING THE SYSTEM and MENU DESCRIPTION

This section discusses the menu structure of the system through a series of screenshots that show all related functions and features. Some menus are password protected and access is allowed according to the credentials of the operator as reported in sections 1.3. The menu navigation is controlled by the keyboard of the master's front panel as described herein.

### 6.1 Menu Navigation

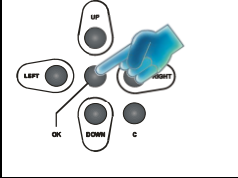
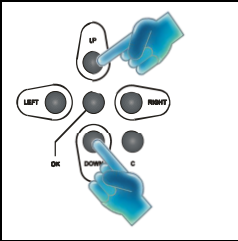
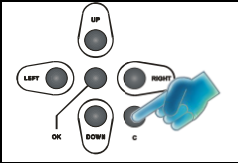
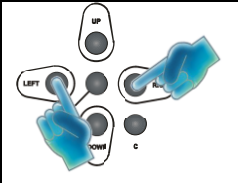



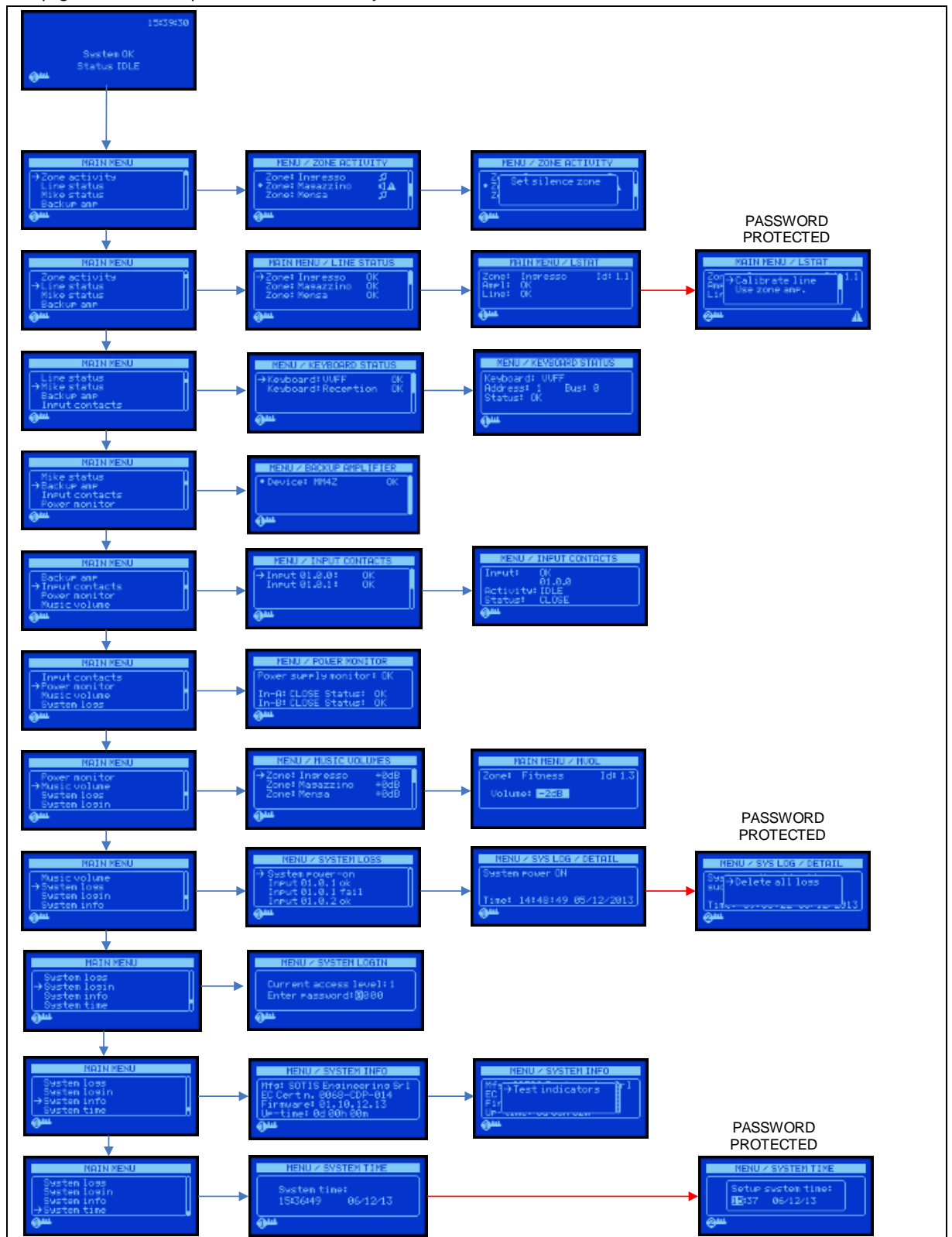

	<p>From the home screen indicating SYSTEM OK or SYSTEM IDLE, press the OK button to access the menu list. In all sub menus, the OK button is used to confirm the selection of the element pointed by the navigation arrow.</p>
	<p>To scroll through the list of menus and sub-menus, use the UP and DOWN keys. To enter the menu or sub-menu pointed by the arrow navigation, press OK.</p>
	<p>To return to the previous menu or cancel the selection of a function, press the BACK key.</p>
	<p>Alternatively, you can enter the menu or sub-menu by pressing the RIGHT key, and return to the previous menu or sub-menu by pressing the LEFT key. When surfing through the menus, the RIGHT and LEFT have the same effect as the OK and BACK keys.</p>

## 6.2 Menu tree

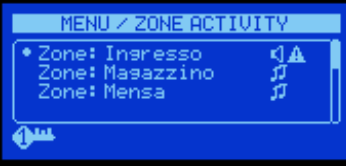
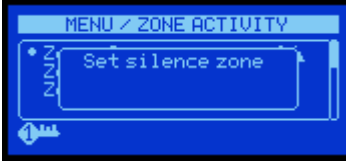

This page shows the complete menu tree for the system

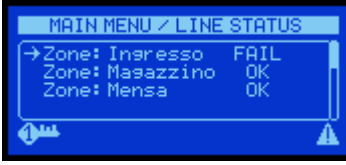
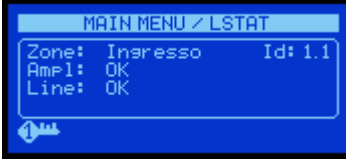







### 6.3 Description of the system menu

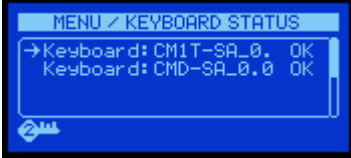

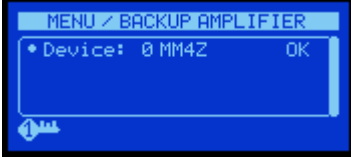
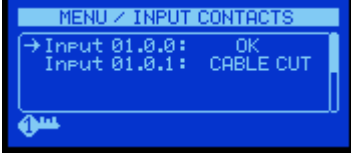

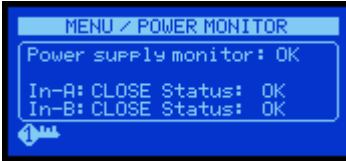
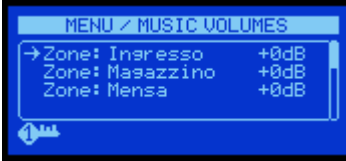

<p><b>ZONE ACTIVITY Menu</b></p>  	<p>ZONE ACTIVITY menu indicates the status of the zones configured on the system. The areas are identified by the name assigned during the configuration with the BEST software. The state is identified by the following icons on the right of the screen:</p> <ul style="list-style-type: none"> <li>: a general announcement is being played on the zone</li> <li>: an alarm message is being played (or spoken) on the zone</li> <li>: background music is enabled on the zone</li> <li>: the zone is silenced</li> </ul> <p>When a message or audio content is broadcasted on the zone, it is possible to silence (mute) the zone. To silence a zone, select it with the up and down keys, then press OK. If the zone is already muted, the same action will un-silence it. If a zone is silenced when the system is playing a recorded alarm message, the system will play the alarm message until its end before silencing the zone. On the other hand, if silencing is removed when after the alarm message has been triggered, the system will play the message from the beginning.</p> <p>In case a live alarm message is spoken live from a microphone call station and a silencing command is entered, the system will mute the zone instantly and with no delay.</p>
<p><b>LINE STATUS Menu</b></p>   	<p>Indicates the status of operation of a zone</p> <p>The lines/zones are identified by the name given during the configuration with the BEST software</p> <p>The status is summarized with:</p> <ul style="list-style-type: none"> <li>• OK - normal operation</li> <li>• FAIL - fault warning</li> </ul> <p>LINE STATUS sub-menu provides detailed information about the selected zone, its power amplifier and loudspeaker line.</p> <p>According to the configuration assigned with the BEST software, the zone can be configured in three ways:</p> <ul style="list-style-type: none"> <li>• NO power amplifier monitoring, NO loudspeaker line monitoring</li> <li>• Monitored power amplifier, NO loudspeaker line monitoring</li> <li>• Monitored amplifier, monitored loudspeaker line.</li> </ul> <p>On top of the screen, the system displays the name of the zone given during the configuration with the BEST software. On the right, the physical address of the EV MCL1Z module assigned to the zone; the first digit (left) indicates where the module is installed (1: master; 2 to 20: slave), the second digit indicates the slot number.</p> <p>If a SEVERE ERROR is detected, the following information will be shown on the display:</p> <ul style="list-style-type: none"> <li>• <b>COMMUNICATION ERROR</b> The EV MCL1Z is not communicating properly with the master or slave unit where it was installed. Under this condition, the module and its associated line/zone are not operational.</li> <li>• <b>NO CONFIGURATION</b> Indicates an error in the operating parameters of the zone module; a check of the configuration of the system on the BEST software is needed. Under this condition, the module and its associated line/zone are not operational.</li> <li>• <b>CALIBRATION ERROR / Load disconnected</b> Indicates that the speaker line is not calibrated or that the calibration process has failed. Under this condition, the system will disconnect the speakers to prevent a damage to the power amplifier. The loudspeaker line will not be operational.</li> </ul>

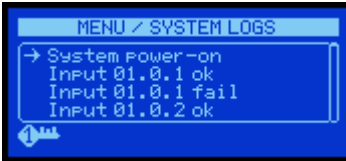

	<ul style="list-style-type: none"> <li>• <b>LINE SHORT TO GROUND / Load disconnected</b> Indicates that a ground fault was detected on the loudspeaker line (impedance between the loudspeaker ground is less than 50 Ohm). Under this condition, the system will disconnect the loudspeakers from the amplifier in order to prevent a damage. The loudspeaker line will not be operational.</li> <li>• <b>LINE SHORTED / Load disconnected</b> Indicates that a short circuit has been detected on the loudspeaker line. Under this condition, the system will disconnect the loudspeakers from the amplifier in order to prevent a damage. The loudspeaker line will not be operational.</li> <li>• <b>LINE OVERCHARGE / Load disconnected</b> The system has measured a loudspeaker line impedance that will overload the power amplifier. Specifically, the load impedance is too low for the amplifier connected to the zone module. Under this condition, the system will disconnect the loudspeakers from the amplifier in order to prevent a damage. The loudspeaker line will not be operational.</li> </ul> <p><b>Power amplifier status</b></p> <ul style="list-style-type: none"> <li>• <b>CHECK DISABLED</b> The monitoring of the power amplifier is disabled</li> <li>• <b>BACKUP OK</b> The zone is working with the backup amplifier because of a failure to the main amplifier connected to the line module. The backup amplifier is fully operational</li> <li>• <b>BACKUP FAIL</b> The zone module switched to the backup amplifier because of a failure in the main amplifier. Additionally, some parameters of the backup amplifier are not validated.</li> <li>• <b>FAIL</b> The line module has detected a failure in the main power amplifier; it is possible that the amplifier is faulty. The loudspeaker line is not switched to the backup amplifier because it is not installed or is used by another line module.</li> <li>• <b>OK</b> The power amplifier has all parameters in the correct range and is fully operational.</li> </ul>
  	<p><b>Loudspeaker line status</b></p> <ul style="list-style-type: none"> <li>• <b>CHECK DISABLED</b> The monitoring of the loudspeaker line is disabled.</li> <li>• <b>UNKNOWN</b> The line monitoring cannot be performed because of a failure to the power amplifier. The status of the loudspeaker line is thus unknown.</li> <li>• <b>UNDERLOAD</b> A load loss has been detected in the loudspeaker line. The impedance is higher than the one measured during the initial line calibration.</li> <li>• <b>OVERLOAD</b> A higher load has been detected in the loudspeaker line. The impedance is lower than the one measured during the initial line calibration.</li> <li>• <b>OPEN</b> Indicates that there is no load connected to the system: the loudspeaker line is open.</li> <li>• <b>OK</b> The loudspeaker line has all its parameters within the ranges acquired during the initial calibration. Loudspeakers are fully functional.</li> </ul> <p><b>POP-UPS in Line Status sub-menu</b></p> <p>If the system is in access level 2, it is possible to perform some actions on the loudspeaker lines and amplifiers. These features are accessible by pressing the OK key once in the line status sub-menu. The system will display two options:</p> <ul style="list-style-type: none"> <li>• <b>CALIBRATE LINE</b> This command performs the calibration of the selected line. The system will set the amplifier volume level so that its output will reach 100Vac and it will read the initial loudspeaker line parameters (impedance and power). These parameters will be stored and used as the reference for the continuous monitoring of loudspeaker line and amplifier. All eventual fault warnings will be reset. The line calibration has also the purpose of setting the 0dB reference; specifically, 0dB will correspond to 100V on the loudspeaker line, intended as full power.</li> </ul>

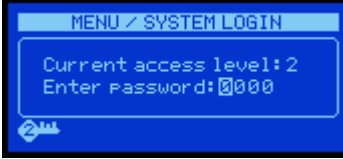

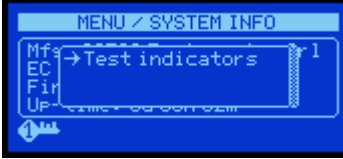
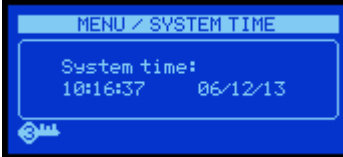
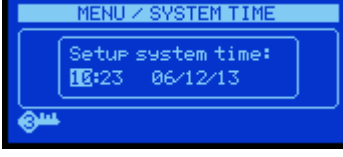



















	<ul style="list-style-type: none"> <li>• <b>USE ZONE AMP</b> This command forces the line module to switch to main zone amplifier. This command should be used in case the zone module has previously switched to the backup amplifier (due to a main amplifier fault detection), or it can be used as a reset of the loudspeaker line status after a short circuit or a ground leakage detection.</li> </ul>
<p><b>KEYBOARD STATUS Menu</b></p>  	<p>KEYBOARD STATUS menu indicated the operating condition of the microphone stations connected to the system. The call stations are identified by the name assigned during the configuration performed through the BEST software. The display will summarize the state as follows:</p> <ul style="list-style-type: none"> <li>• <b>OK</b> The station is fully operational and with no failures.</li> <li>• <b>ERR</b> The call station, if set as a firemen's unit, has a failure.</li> <li>• <b>WRN</b> The call station, if set as generic, has a failure.</li> </ul> <p><b>KEYBOARD STATUS sub-menu</b> This sub-menu gives all information about the status of the selected call station. The status is summarized on the bottom line as follows:</p> <ul style="list-style-type: none"> <li>• <b>OK</b> The station is fully operational and with no failures.</li> <li>• <b>ERROR</b> The call station, if set as a firemen's unit, has a failure.</li> <li>• <b>WARNING</b> The call station, if set as generic, has a failure.</li> </ul> <p>In case of a fault, the display will show an additional line with further details:</p> <ul style="list-style-type: none"> <li>• <b>COMUNICATION ERROR</b> The call station does not communicate with the system. Check the cable and connections.</li> <li>• <b>WRONG KEYBOARD TYPE</b> The call stations model is different than the one configured with the BEST software.</li> <li>• <b>MIKE FAIL (Short)</b> The microphone capsule is shorted. Return the unit for servicing/repair.</li> <li>• <b>MIKE FAIL (Open)</b> The microphone capsule is unconnected. Return the unit for servicing/repair.</li> </ul>
<p><b>BACKUP AMPLIFIER Menu</b></p> 	<p>This menu provides a list of all spare amplifiers connected to the system in the master and in all slave units, as defined during the configuration through the BEST software. The status is displayed as follows:</p> <ul style="list-style-type: none"> <li>• <b>OK</b> Spare amplifier is fully operational</li> <li>• <b>FAIL</b> A fault was detected on the spare amplifier.</li> <li>• <b>IN USE</b> The spare amplifier is used by one of the modules inside the unit.</li> <li>• <b>DISABLED</b> The spare amplifier is disabled and/or not installed according to the configuration through the BEST software.</li> </ul>
<p><b>INPUT CONTACTS Menu</b></p> 	<p>This menu lists the status of the monitored inputs that will trigger the alarm messages according to the configuration through the BEST software. Each input is identified according to its address as follows: <i>Unit-id.Slot.Input</i></p> <ul style="list-style-type: none"> <li>• <b>Unit-id</b> Is the Master or Slave unit where the EV MCL1Z module (that has the inputs onboard) is installed: 1= Master, 2= first Slave in the chain, 3= second slave in the chain, etc...</li> <li>• <b>Slot</b> Indicates the slot number where the EV MCL1Z is installed: 1= first slot, 2= second slot, 3= third slot, etc... 0= is referred to the contacts on the EV PROM5Z master unit.</li> <li>• <b>Input</b> Identifies the input, 1 or 2.</li> </ul> <p>The status of the input can be as follows:</p> <ul style="list-style-type: none"> <li>• <b>CABLE SHORT</b> The cable is shorted, the input is not functional</li> <li>• <b>CABLE CUT</b> The cable is opened, the input is not functional.</li> <li>• <b>OK</b> The cable is intact, no fault is detected.</li> </ul>

	<p><b>INPUT CONTACTS sub-menu</b>  This sub-menu gives detailed information about each input.  The selected input is identified according to its address as follows:: <i>Unit-id.Slot.Input</i></p> <ul style="list-style-type: none"> <li>• <b>Unit-id</b>  Is the Master or Slave unit where the EV MCL1Z module (that has the inputs onboard) is installed: 1= Master, 2= first Slave in the chain, 3= second slave in the chain, etc...</li> <li>• <b>Slot</b>  Indicates the slot number where the EV MCL1Z is installed: 1= first slot, 2= second slot, 3= third slot, etc... 0= is referred to the contacts on the EV PROM5Z master unit.</li> <li>• <b>Input</b>  Identifies the input, 1 or 2.</li> </ul> <p><b>NOTE: if the ! (exclamation mark) is displayed next to the address of the input, the recorded message triggered by the input is an alarm message.</b></p> <p>The system will detail the activity of the input according to the configuration through the BEST software:</p> <ul style="list-style-type: none"> <li>• <b>IDLE</b>  No message is being broadcasted</li> <li>• <b>ACTIVE</b>  The message associated to the input is being broadcasted</li> </ul> <p>The status of the input is reported as follows</p> <ul style="list-style-type: none"> <li>• <b>CABLE SHORT</b>  The cable is shorted, the input is not functional.</li> <li>• <b>CABLE CUT</b>  The cable is opened, the input is not functional.</li> <li>• <b>CLOSE</b>  The cable is intact, the contact is closed.</li> <li>• <b>OPEN</b>  The cable is intact, the contact is open.</li> </ul>
<p><b>POWER MONITOR Menu</b></p> 	<p>This menu provides the information about the power supply. The status is detected by the A and B contacts. The meaning of A and B will depend on the information provided by the dry contact of the chosen power supply unit; please refer to the unit's manual. The status of each input can be:</p> <ul style="list-style-type: none"> <li>• <b>CLOSE/OK</b></li> <li>• <b>OPEN/ERROR</b></li> </ul>
<p><b>MUSIC VOLUME Menu</b></p>  	<p>This menu lists the zone where background music is enabled and configures the volume.  The zones are identified by the name assigned during the configuration through the BEST software. The output volume is expressed in dB (decibels)</p> <p><b>Music Volume sub-menu</b>  The sub-menu sets the background music on each zone through the UP/DOWN keys. Once a new volume is set, press OK to confirm.  The configurable dB values are: +4, +2, +1, 0, -1, -2, -3, -4, -5, -6, -7, -8, -16, -24, -32, MUTE.</p>
<p><b>SYSTEM LOGS Menu</b></p> 	<p>This menu lists in a chronological order all system events. Each event is identified by a brief description and, to display further details, select the log with the UP/DOWN keys, then press OK.</p> <p><b>LOG DETAIL sub-menu</b></p>

 	<p>This screenshot summarizes the details of the selected log Please refer to the LOGS TABLE for further details</p> <p><b>Pop-Up in LOG DETAIL sub-menu</b> If the system is in access level 2 or 3, it is possible to cancel the log list by pressing the OK key once in logs details sub-menu.</p> 
<p><b>LOGIN Menu</b></p> 	<p>This menu provides the access to levels 2 and 3. The passwords are defined through the BEST software. To insert a password, select each the digit with the LEFT/RIGHT keys, change the digit with UP/DONW keys and confirm with OK. The system acknowledges the new access level by indicating it with the number inside the key icon on the bottom left of the screen. A password error sets a lower access level.</p> 
<p><b>SYSTEM INFO Menu</b></p>  	<p>This menu gives some information about the system:</p> <ul style="list-style-type: none"> <li>• Name of the legal manufacturer</li> <li>• EN54-16 certificate number</li> <li>• Firmware version</li> <li>• Time since last power up</li> </ul> <p><b>SYSTEM INFO pop-ut menu</b> In the SYSTEM INFO menu, press OK to test all system indicators. This function will activate all visual and acoustic indicators for 3 seconds</p>
<p><b>SYSTEM TIME Menu</b></p>  	<p>This menu shows the current date and time The format is:</p> <ul style="list-style-type: none"> <li>• Hours : munites :seconds</li> <li>• Day : month : year</li> </ul> <p><b>Pop-Up menu SYSTEM TIME</b> In access levels 2 and 3, the user may set the system clock with the LEFT/RIGHT keys to select the field and with UP/DOWN keys to change the value. Once done, press OK to confirm.</p> 

## 6.4 LOGs Table and System Troubleshooting

This table describes the system logs and the troubleshooting actions; each log is time-stamped as seen previously

Fault	Display indication	Log details - press OK key to access	Description	Troubleshooting
	<i>System power-on</i>	<i>System power ON</i>	Indicates the system has been powered up	
X	<i>SD/MMC failure</i>	<i>SD/MMC Communication fail</i>	Failure in the communication between the uSD card and the Master unit.	 Check the uSD card. Eventually, remove the card, format it with your PC and reload the content with the BEST software.
	<i>SD/MMC fail resume</i>	<i>SD/MMC Communication OK error resume</i>	The uSD communication error has been recovered	
X	<i>System conf. fail</i>	<i>System configuration fail</i>	The configuration of the system is not correct	 Check the BEST project then reload the configuration.
X	<i>MSU5 spare amp. fail</i>	<i>MSU5 spare amplifier fail</i>	The system has detected a fault on the backup amplifier connected to the EV PROM5Z master unit	 Check the backup amplifier and connections to the master unit
	<i>MSU5 spare amp. ok</i>	<i>MSU5 spare amplifier OK error resume</i>	The backup amplifier fault has been recovered	
x	<i>ESU8-x comm. fail</i>	<i>ESU8-x error communication lost</i>	The system has detected a fault in the "x" EV PRO58Z in the chain	 Check all connections to the slave unit and check that the unit is powered
	<i>ESU8-x comm. ok</i>	<i>ESU8-xOK comm. error resume</i>	The communication error in the slave unit chain has been recovered.	
x	<i>MSU5 int. failure</i>	<i>MSU5 internal fail Flash error</i>	The master unit EV PROM5Z has a fault in its internal memory	 Call for servicing.
x	<i>ESU8-x amp. error</i>	<i>ESU8-x error spare amplifier fail</i>	The system detected a fault to the spare amplifier installed in the "x" ESU08 slave in the chain	 Check the spare amplifier and its connections.
	<i>ESU8-x amp. ok</i>	<i>ESU8-x spare amp. OK error resume</i>	The backup amplifier fault has been recovered	
x	<i>ESU8-x A.B. error</i>	<i>ESU8-x error audio bus unplugged</i>	The connection cable to the "x" slave in the chain is faulty	 Check the cables from an to the "x" slave module in the chain
	<i>ESU8-x A.B. ok</i>	<i>ESU8-x audio bus OK error resume</i>	The cable connection fault has been recovered	
x	<i>Comm fail **name**</i>	<i>LMM1 communication error Position: MSU5 slot-x or Position: ESU8-y slot-x Zone name: xxxxx</i>	Communication error between the master unit and the line module installed in nr. "x" slot of the master unit or communication error between the line module installed in nr "x" slot of the nr "y" slave unit in the chain.	 Check that the line module is inserted correctly inside the indicated master or slave unit. Check the connection cables of the master-slave chain. Reboot the system. If the fault does not recover, call for servicing.
	<i>Comm OK **name**</i>	<i>LMM1 comm. error resume Position: MSU5 slot-x or Position: ESU8-y slot-x Zone name: xxxxx</i>	The communication error indicated above has been recovered	
x	<i>Msg. fail **name**</i>	<i>LMM1 int. message error Position: MSU5 slot-x or Position: ESU8-y slot-x Zone name: xxxxx</i>	Message storage error on the line module installed in nr. "x" slot of the master unit or on the line module installed in nr "x" slot of the nr "y" slave unit in the chain.	 Reboot the system to automatically reload the message. If the fault does not recover, call for servicing.
	<i>Msg. OK **name**</i>	<i>LMM1 mess. error resume Position: MSU5 slot-x or Position: ESU8-y slot-x Zone name: xxxxx</i>	The storage error indicated above has been recovered	
x	<i>Line fail **name**</i>	<i>LMM1 line to ground error LMM1 line open error LMM1 line underload error LMM1 line overload error LMM1 line overcharge error LMM1 line short error Position: MSU5 slot-x or Position: ESU8-y slot-x Zone name: xxxxx</i>	Indicates a fault in the loudspeaker line -Ground leakage. -Line open -Load loss -Load increase -Overload -Line shorted The system indicated on which module the fault has occurred and zone name	 Check the impedance of the loudspeaker line. Check the cables.
	<i>Line OK **name**</i>	<i>LMM1 line to ground OK LMM1 line open OK LMM1 line underload OK LMM1 line overload OK LMM1 line overcharge OK LMM1 line short OK Position: MSU5 slot-x or Position: ESU8-y slot-x Zone name: xxxxx</i>	The indicated fault (see above) has been recovered	
x	<i>Cal. fail **name**</i>	<i>LMM1 calibration error Position: MSU5 slot-x or Position: ESU8-y slot-x Zone name: xxxxx</i>	The calibration line on the indicated module and zone name has failed. The system was not able to set the amplifier gain for 100V output voltage.	 Check the impedance of the loudspeaker line and check that the power amplifier is able to drive the load. Increase or decrease slightly the amplifier volume on its potentiometer and perform calibration again.
	<i>Cal. OK **name**</i>	<i>LMM1 calibration OK Position: MSU5 slot-x or Position: ESU8-y slot-x Zone name: xxxxx</i>	The calibration process of the indicated line was successful and all parameters for line and amplifier monitoring were acquired.	
x	<i>Amp. fail **name**</i>	<i>LMM1 amplifier fail. Position: MSU5 slot-x or Position: ESU8-y slot-x Zone name: xxxxx</i>	The system has detected a fault on the main amplifier connected to the indicated line module	 Check the power amplifier and eventually replace it. If replaced, perform line calibration
	<i>Amp. OK **name**</i>	<i>LMM1 amp. OK fail resume Position: MSU5 slot-x or Position: ESU8-y slot-x Zone name: xxxxx</i>	The fault on the indicated power amplifier has been recovered.	



	Use spare **nome**	LMM1 use spare amplifier Position: MSU5 slot-x or Position: ESU8-y slot-x Zone name: xxxxx	The indicated line module has switched to the backup power amplifier.	
	Own amp. **nome**	LMM1 release spare amp. Position: MSU5 slotx or Position: ESU8-y slot-x Zone name: xxxxx	The line module switched back to its main amplifier	
x	Comm fail **nome**	LRM1 communication error Position: MSU5 slot-x or Position: ESU8-y slot-x Zone name: xxxxx	Communication error between the master unit and the line B module installed in nr. "x" slot of the master unit or communication error between the line module installed in nr "x" slot of the nr "y" slave unit in the chain.	Check that the line B module is inserted correctly inside the indicated master or slave unit. Check the connection cables of the master-slave chain. Reboot the system. If the fault does not recover, call for servicing.
	Comm OK **nome**	LRM1 comm. error resume Position: MSU5 slot-x or Position: ESU8-y slot-x Zone name: xxxxx	The communication error (see above) has been resumed.	
x	Line fail **nome**	LRM1 line to ground error LRM1 line open error LRM1 line underload error LRM1 line overload error LRM1 line overcharge error LRM1 line short error Position: MSU5 slot x or Position: ESU8-y slot-x Zone name: xxxxx	Indicates a fault in the loudspeaker line B -Ground leakage. -Line open -Load loss -Load increase -Overload -Line shorted The system indicated on which module the fault has occurred and zone name	Check the impedance of the loudspeaker line
	Line OK **nome**	LRM1 line to ground OK LRM1 line open OK LRM1 line underload OK LRM1 line overload OK LRM1 line overcharge OK LRM1 line short OK Position: MSU5 slot-x or Position: ESU8-y slot-x Zone name: xxxxx	The indicated fault (see above) has been recovered	
x	Meas fail **nome**	LRM1 Measure failure Position: MSU5 slot-x or Position: ESU8-y slot-x Zone name: xxxxx	Detection of a fault during the monitoring of the loudspeaker line B.	Check the connection between the power amplifier and the EV MCL2Z module. Check the impedance of the loudspeaker line.
	Meas OK **nome**	LRM1 Measure OK Position: MSU5 slot-x or Position: ESU8-y slot-x Zone name: xxxxx	The fault on loudspeaker line B has been resumed.	
x	Link fail **nome**	LRM1 Amplifier link failure Position: MSU5 slot-x or Position: ESU8-y slot-x Zone name: xxxxx	The power amplifier is not connected to the EV MCL2Z module.	Check the connection between the power amplifier and indicated EV MCL2Z module.
	Link OK **nome**	LRM1 Amplifier link OK Position: MSU5 slot-x or Position: ESU8-y slotx Zone name: xxxxx	The fault on the connection between the power amplifier and line B module (see above) has been resolved	
x	Mike X.Y comm. fail	Microphone consolle X.Y communication error	The microphone station nr X, connected to the bus nr Y does not communicate with the system.	Check the cables Check that the microphone station has the address set accordingly to the configuration on the BEST software.
	Mike X.Y comm. ok	Microphone consolle X.Y comm. Error resume	The connection error (see above) has been resumed	
x	Mike X.Y cap. fail	Microphone consolle X.Y capsule open error or capsule short error	The call station nr X, connected to the bus nr Y has a damaged microphone capsule (open or shorted).	Call for servicing or replace the unit
	Mike X.Y cap. ok	Microphone consolle X.Y capsule open err. resume or capsule short err. resume	The microphone capsule failure has been resolved	The system will indicate this if a new call station with the same configuration has been plugged into the bus.
x	Mike X.Y type fail	Microphone consolle X.Y wrong type connected	The call station nr X, connected to the bus nr Y is a different model than the one configured on the BEST software	Check the configuration on the BEST software and modify accordingly Check the call station settings (dip-switch).
	Mike X.Y type ok	Microphone consolle X.Y wrong type resume	The error above has been resumed	
x	Power supply A fail	Power supply fail error on input A	The power supply unit (external to the system) has reported a fault on input A	Check the power supply unit according to the manufacturer's indications.
	Power supply A ok	Power supply error on input A resume	The power supply fault in input A has been resumed	
x	Power supply B fail	Power supply fail error on input B	The power supply unit (external to the system) has reported a fault on input B	Check the power supply unit according to the manufacturer's indications.
	Power supply B OK	Power supply error on input B resume	The power supply fault in input B has been resumed	
x	System conf. changed	System event configuration changed	The system has detected a change in the configuration; a new configuration was downloaded though the BEST software.	Reboot the system
	System USB plug	System event USB plugged	The system has been plugged to a PC via the USB port	
	System old-time	System event, time setup previous time log	The system clock has been updated. This log has the old timestamp.	
	System new-time	System event, time setup new time log	The system clock has been updated. This log has the new timestamp.	
	Alarm message START	Alarm message START MSU5 slot-x in-z	The system started to play a recorded alarm message triggered by an input contact.	











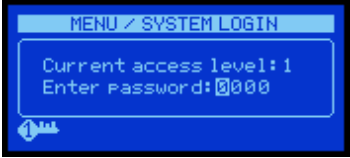

		or ESU8-y slot-x in-z	The location of the message is described as follows: MSU05, slot nr "x", input nr "z"; or ESU08 nr "y" in the chain, slot "x", input nr "z"	
	Alarm message STOP	Alarm message STOP MM4Z slot-i in-m or MS8Z-n slot-i in-m	The system ended to play an alarm recorded message triggered by an input contact. The location of the message is described as follows: MSU05, slot nr "x", input nr "z"; or ESU08 nr "y" in the chain, slot "x", input nr "z"	
x	Input X.Y.Z fail	Input cable cut MSU5 slot-x in-z or ESU8-y slot-x in-z	The cable on a monitored input contact has been cut. The location of the input is described as follows: MSU05, slot nr "x", input nr "z"; or ESU08 nr "y" in the chain, slot "x", input nr "z"	Check the cable and the termination resistors
	Input X.Y.Z ok	Input cable cut resume MSU5 slot-x in-z or ESU8-y slot-x in-z	The cable cut fault has been resumed.	
x	Input X.Y.Z fail	Input cable short error MSU5 slot-x in-z or ESU8-y slot-x in-z	The cable on a monitored input contact is shorted. The location of the input is described as follows: MSU05, slot nr "x", input nr "z"; or ESU08 nr "y" in the chain, slot "x", input nr "z"	Check the cable and the termination resistors.
	Input X.Y.Z ok	Input cable cut error MSU5 slot-x in-z or ESU8-y slot-x in-z	The cable short fault has been resumed.	
	Alarm message START	Alarm message START microphone consolle X.Y	The system started to play a recorded alarm message triggered manually from the call station nr "x" connected the the bus nr "y"	
	Alarm message STOP	Alarm message STOP microphone consolle X.Y	The system ended to play a recorded alarm message triggered manually from the call station nr "x" connected the the bus nr "y"	
	System auth.	System authentication success on level x or fail on level x	An authentication to a different access level was attempted. The system will report of operation was "success" or "fail" the new current access level is also reported	
x	System failure	System failure log system error	An issue has occurred during the recording of a log; the system was not able to write the log	This is considered as a severe damage: call for servicing.
	System log reset	System event log memory reset	The entire log-list has been cancelled	
x	SD/MMC failure	SD/MMC failure error	A communication error between the system and the uSD card has been detected	Format the card on a PC and reload the contents with the BEST software. If the failure persist, repeat the operation with a new uSD card.
x	System int. bus fail	System failure internal bus error	A communication error on the internal bus has been detected	First, remove and replug all modules. If the failure persists, it will be intended as a severe damage: call for servicing.
x	SD/MMC content fail	SD/MMC content failure files checksum error	The uSD content does not match the system configuration and design on the BEST software	Format the card on a PC and reload the contents with the BEST software.
	SD/MMC content OK	SD/MMC content OK checksum err. resume	The uSD content is coherent with the system configuration and design on the BEST software	
x	System conf fail	System configuration fail	The configuration of the system has an error. A description of the error is also reported	Download configuration through the BEST tool. If the issue persists, call for servicing.
x	Reset by watchdog!	System reset Watch-Dog reset	The system has been reset by the internal supervisor circuitry.	If the issue persists, call for service.

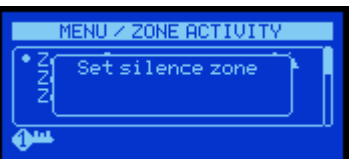









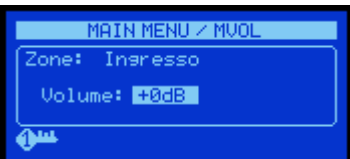

## 7. OPERATIONS AND PROCEDURES

This section discusses the procedures that can be performed on the system through the commands entered on the EV PROM5Z master unit.

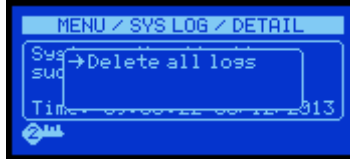
All operations described herein are mainly about the diagnostics and the reporting of the state of the system. All information about the configuration, design of the system setup and operating rules of the system are performed through the BEST software.

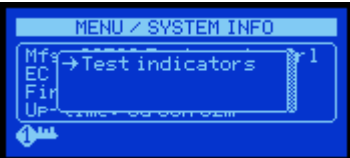
<h3>7.1 Authentication</h3> 	<p>To enter a deeper access level, a password is required. The password for each level is set in the BEST software configuration.</p> <p>To change the access level, enter the AUTHENTICATION menu, then enter the password with LEFT/RIGHT keys to select the digit and the UP/DOWN keys to change the digit. Finally, press OK.</p> <p>If the password was set correctly, the system will enter the new access level, as indicated with the number inside the key symbol. If the password is wrong, the system will get back to a lower access level.</p> <p>After two minutes of inactivity in access levels 2 and 3, the system will return to access level 1.</p> <p><b>Operations available at access level 2:</b> </p> <ul style="list-style-type: none"> <li>• Loudspeaker lines calibration</li> <li>• Restoring zone functions on the main power amplifier</li> <li>• System logs cancelling</li> <li>• System date and time change.</li> </ul> <p><b>Operations available at access level 3:</b> </p> <ul style="list-style-type: none"> <li>• All operations available at access level 2</li> <li>• System configuration download through the USB port</li> </ul>
<h3>7.2 Silencing a zone</h3> 	<p> In case of an alarm message, Silencing or unsilencing of a zone is done at access level 1.</p> <p> To silence or unsilence a zone, enter the ZONE ACTIVITY menu, select the desired zone with the UP/DOWN keys, press OK to enter the sub-menu. Then, select:</p> <ul style="list-style-type: none"> <li>• “Set silence zone” to silence the zone</li> <li>• “Remove silence” to unsilence the zone</li> </ul> <p>The system will execute command in two different ways:</p> <ul style="list-style-type: none"> <li>• In case of a recorded message, the system will play it until its end and will not repeat it. If silencing is removed, the system will start playing the message from the beginning.</li> <li>• If the message is spoken live through a call station set for evacuation purposes, the system will silence the zone instantly.</li> </ul>
<h3>7.3 Line calibration</h3> 	<p> Line calibration is performed at access levels 2 or 3. Enter the LINE STATUS menu, then press OK. The system will show a list with all loudspeaker lines that are present in the setup. Select the desired zone with the UP/DOWN keys, then press OK. Press OK once more to access the sub-menu, then select CALIBRATE LINE and confirm with the OK key. The system will now perform the line calibration; a 1Khz tone is feeded to the loudspeaker line.</p> <p> The line calibration automatic procedure will set the line module output volume so that the voltage that the power amplifier feeds to the line is 100V nominal. This operation has the purpose to set the 0dB reference (full power) and verify that the amplifier is able to effectively drive the loudspeaker line and to measure the line parameters (impedance and power) as the reference for the continuous monitoring.</p> <p>As mentioned above, the system will set full output power as the 0dB reference. All volume controls within the Proevac are expressed in dBs and are intended an attenuation in comparison to the 0dB reference.</p> <p> The volume control of the amplifier is done in discrete steps; the system will set the amplifier volume on the step that its output will fall in a window +/- 10% wide window that is centered on 100Vac.</p> <p>In case the system reports CALIBRATION FAIL indication after the execution of the procedure, try to slightly increase or decrease the amplifier volume through its potentiometer and perform calibration again. This will help the system to find a volume step that will likely fall into the acceptance window.</p> <p>If the problem persists, it is advisable to check the loudspeaker line and its wiring.</p> <p> <b>WARNING!</b> At the first power up after configuration download, all lines need to be calibrated individually.</p>
<h3>7.4 Restoring primary amplifier</h3>	

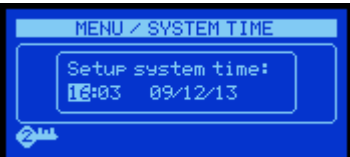

	 <p>If a failure is detected on a main power amplifier, the system will switch to the spare amplifier if this is installed and if it is not being used on another line. After the main amplifier has been replaced or serviced, it is necessary to tell the system to switch back to the main amplifier. This because, in case of a failure and switch to backup unit, Proevac will totally isolate the faulty device to protect the system and loudspeaker line, thus the monitoring of it will be disabled and the system will not know if regular operation is restored.</p> <p>To switch back to the main amplifier, first enter access level 2. Then access the LINE STATUS menu. The system will list all lines and will indicate the faulty ones. Select the desired line and press OK, then select the USE ZONE AMP in the pop-up.</p>  <p>Even if the main amplifier is repaired or replaced after a fault, the system will not switch back to it automatically. Manual switchback is always required.</p>
<p><b>7.5 Background music volume</b></p> 	 <p>To set the background music volume, access the MUSIC VOLUME menu, then press OK. The system will display the lines where background music is enabled; this depends on the configuration given through the BEST software. Select the desired line, then press OK. The dB values settable by the UP/DOWN keys are : +4, +2, +1, 0, -1, -2, -3, -4, -5, -6, -7, -8, -16, -24, -32, MUTE. Once the new volume is selected, confirm with the OK key.</p>
<p><b>7.6 Cancelling the log list</b></p> 	 <p>Log list cancelling is allowed at access levels 2 and 3 only. Once at the correct access level, select the SYSTEM LOGS menu and press OK. The system will list all recorded logs. To cancel the log list, press OK, select DELETE ALL LOGS and confirm with the OK key.</p>
<p><b>7.7 System indicators test</b></p> 	 <p>To test all system visual and acoustic indicators, access the SYSTEM INFO menu, then press OK. Press OK once more to show the pop-up menu, then confirm with the OK key.</p> <p>The test will last for about 3 seconds and the user should observe the following:</p> <ul style="list-style-type: none"> <li>• all leds on master and slave frontpanels are ON</li> <li>• all led on line modules installed in the slots are ON</li> <li>• all leds on microphone stations are orange</li> <li>• all display dots are activated, the display will be all white</li> <li>• all buzzers on master unit and call stations will buzz.</li> </ul>
<p><b>7.8 Date and time setting</b></p> 	 <p>Date and time can be changed only at access levels 2 and 3. The user may set the system clock with the LEFT/RIGHT keys to select the field and with UP/DOWN keys to change the value. Once done, press OK to confirm.</p>
<p><b>7.9 Configuration download</b></p>	 <p>The download of the configuration through the BEST software is performed at access level 3 only. To activate the USB port, first log at access level 3. If the system is in access level 1 or 2, the download button on the BEST software will be disabled.</p> <p>If a new configuration is downloaded in a blank system, both USB download and uSD generation must be performed through the BEST software. First, generate the uSD, install it in the system, then access to level 3 and download configuration. In case of an update or modification to the configuration of an existing system, if no changes are made to the recorded messages assignments, it is not necessary to re-created the uSD card.</p> <p><b>WARNING:</b> unpower the system before uSD installation or removal from the master unit.</p>



## TECH NOTE: calibration and continuous monitoring of loudspeaker line and power amplifier

During the design of the Proevac, a great attention was given to the monitoring of the loudspeaker line and power amplifier. The monitoring is performed independently on each line and amplifier inside the EV MCL1Z and EV MCL2Z modules. Their primary function is not only to feed the lines with the audio programs, but keeping under strict control all audio path outside the system.

From this point of view, the EV MCL1Z is a real and accurate test instrument, in fact it carries onboard all circuits to precisely measure both current and line voltage and to feed the required stimulus.

The combination of voltage and current line provides the line impedance.

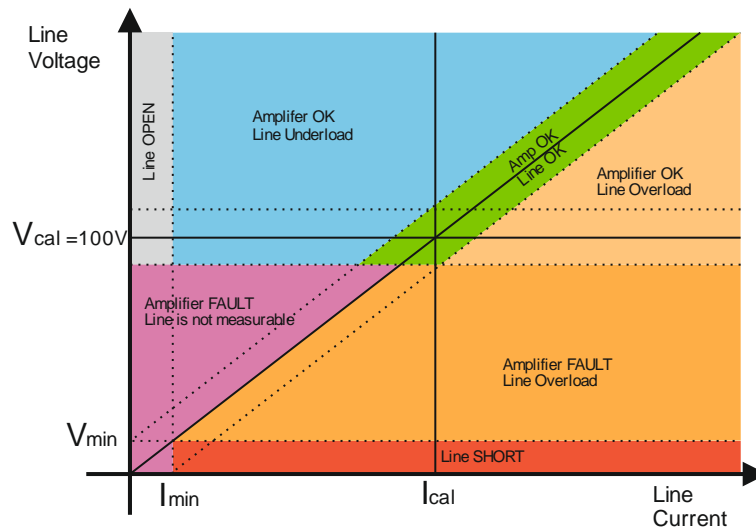

To validate a fault or a regular operational condition, the algorithm performs a measurement of both current and voltage across the line every 40 seconds, it places the values on a graph like the one above and checks in which area the point falls.

The voltage  $V_{cal}$  and current  $I_{cal}$  values are the ones measured and stored during calibration procedure. As seen in the dedicated section, the line module will set the amplifier volume so that its output falls within the acceptance window plotted in the graph by the two dashed lines above and below the horizontal  $V_{cal}=100V$  line.

Once the volume is set, the line module will measure the current that the amplifier feeds to the loudspeakers, the vertical  $I_{cal}$  line on the graph. These parameters are stored and used as the reference for all future monitoring measurements.

The initial calibration is essential for the continuous monitoring, but is also of a great importance to guarantee the performance of the entire system. In fact, it determines and sets the reference for all audio levels settings inside the system. By convention, 100Vac on the loudspeaker line (full power) will correspond to a 0dB volume. All volume settings inside the system are considered as an attenuation (-xx dB) or an amplification (+xx dB) with respect to the reference set during calibration.

If the loudspeaker line is well designed in order to absorb all power provided from the amplifier, the user will be certain that an audio program set a 0dB volume will be diffused with all the available sound pressure.

Back to monitoring. The line module will compute the line impedance according to the formula  $Z=V/I$ . On the graph, the impedance is represented by the oblique line passing through the zero point. The dashed lines above and below is the range of acceptance.

The intersection between the three lines (horizontal, vertical, and oblique) is the initial calibration point that will be used as the reference. The line module will perform a measurement every 40 seconds. The reading is plotted on the graph and the algorithm checks in which area it falls and reports the state of both loudspeaker line and power amplifier.

If both work correctly, the point has fallen into the green area.

If the voltage is above 100V, but the current is lower than  $I_{cal}$ , the system will report that the amplifier is working correctly, but that there was a load loss (underload). In the real world, this will happen if one or more loudspeakers are disconnected from the line.

If the voltage is above 100V and the current is close to zero (grey area), the amplifier is performing correctly, but system will report a total load loss, in other words the load has been disconnected, the system sees an open circuit.

If the amplifier fails, its voltage will be less than 100V. In this case the amplifier will report a power amplifier failure, but no information can be given about the loudspeaker line since there is no source to drive the loudspeakers and perform a current measurement.

On the other side of the graph, if the voltage is above 100V and the current is increased, the system will report an overload condition.

In the real world, this may happen when one or more speakers are added to the line. In this case, the line should be recalibrated in order to get new reference values. If more speakers are added to the line, it is advisable to check if the amplifier has enough power to drive them, otherwise the system will report an overload condition and an amplifier failure during the calibration process. In this case, the system will report an amplifier failure even if there is no real damage since it will simply not be able reach a 100V output voltage on a such severe load.

The short circuit condition is displayed in the lowest area of the graph (red area). The system will report this condition when the amplifier's output voltage drops close to zero but the current has a value higher than zero.

According to this logic, the system monitors the condition of the loudspeaker line and power amplifier and validates the faults.

When a change of state is identified (fault warning), the system will not report it when the first out of range measurement is detected, but will repeat a series of close readings and the fault warning is validated only if all them are comparable. This makes the system extremely robust and reliable against of any false error and fault reporting.

The system implements an additional strategy to minimize the risk of a false fault reporting: it will “follow” the derating of both amplifier gain and line impedance.

There may be several factors that lead to a slight degeneration of these parameters during the life cycle of the equipment: mechanical compliance of the suspension of the loudspeakers, variation in the capacitive reactance in the capacitors used in the electronics and cross-overs, finally the temperature change between night and day.

The system takes into account these slow variations and updates the calibration reference parameters according to the average measurements performed during the continuous monitoring process. Only if the values undergo a sudden change between a cycle of readings and another, the system will validate the fault state.

The average value of these long term drifts is not stored by the system, in other words, the parameters stored during initial calibration are the primary reference.

For this reason, it is advisable to reboot the system as said in section 2, so that the initial calibration values are restored. If after a reboot the system reports a failure, do check carefully the loudspeaker line and power amplifier.



#### **NOTE ON CLASS-D AMPLIFIERS**

Class D or PWM amplifiers have a completely different behaviour in an overload condition if compared to traditional Class AB or Class B devices. If a Class B or AB amplifier is connected to a load that will force him to provide more power than he is able to deliver, its output voltage will decrease (but will remain higher than zero) and distortion will increase. In this case, Proevac will detect a line voltage decrease and a current increase, thus will validate an overload condition.

A Class D in the same operating condition, will detect the overload and engage the internal protection that will shut-down the PWM modulator and set the output stage in a three-state condition. The output voltage will thus be zero. If this happens, Proevac will detect a power amplifier fault and will switch to the spare amplifier if installed. The spare amplifier will have the same behaviour: the amplifier will shut-down and the “protect” led on the front panel will flash. Please refer to the chosen power amplifier manual for further details.

## 8. USING THE MICROPHONE STATIONS

The microphone call stations are the appendix and external devices of the Proevac system.

Through the microphone stations is possible to control the recorded message players, both alarm or generic, and speak live messages, over the selected zones.

Depending on the model, the user can access advanced and flexible features, typical of a public address system.

All units carry onboard indicators that report the status of the system.

All features, assignments and access to the zones are defined during the configuration of the system with the BEST software.

This section discusses the common features to all models and their specific functions.

### 8.1 Common features to all models

	<p><b>System LED</b></p> <p>The system led pointed by the red arrows gives information about the system status:</p> <ul style="list-style-type: none"> <li>• <b>GREEN:</b> the call station is correctly configured and operational; the system is IDLE or BUSY state, no voice alarm is active</li> <li>• <b>RED:</b> the system is in a voice alarm condition</li> <li>• <b>ORANGE:</b> the system has detected a fault</li> <li>• <b>Led OFF:</b> the call station is unpowered or not configured</li> </ul> <p>The indication of a voice alarm condition has a higher priority than a fault condition: if the system is in both a voice alarm condition and has detected a fault, the led will be RED.</p> <p><b>Busy LED</b></p> <p>The BUSY led pointed by the red arrow, indicates if the selected feature or audio content is ready to be broadcasted over the selected zone.</p> <ul style="list-style-type: none"> <li>• <b>GREEN:</b> it is possible to broadcast the audio content by pressing the TALK button</li> <li>• <b>RED:</b> The call station is already broadcasting and audio content, recorded or live.</li> <li>• <b>ORANGE:</b> it is not possible to broadcast the selection since another audio content with higher priority is being broadcasted.</li> <li>• <b>Led OFF:</b> no selection</li> </ul> <p>If the audio content is being broadcasted (BUSY led is RED) and is stopped to play a higher priority message from another unit, the BUSY led will turn to orange.</p> <p><b>TALK key</b></p> <p>The TALK key, pointed by the green arrow, confirms and executes the selection. If no selection is made, pressing it will do no operation.</p> <p>The TALK key operates in two different ways according to the configuration given through the BEST software:</p> <ul style="list-style-type: none"> <li>• <b>PUSH-TO-TALK:</b> the selection is a live spoken message through the unit's microphone. The microphone will be activated over the selected zone and the message will be broadcasted as long as the TALK key is kept pressed. As the button is released, the audio channel will be closed.</li> <li>• <b>ON-OFF:</b> the selected audio content is a recorded message. The player is started as the TALK button is pressed and released. To stop the message, press and release the TALK button once more.</li> </ul>
--	--

## 8.2 EV BME1T Microphone station

	<p>The EV BME1T has just the TALK key and the status leds. The assignment is done through the BEST software. The audio content is broadcasted by pressing the TALK key.</p> <p>When configuring the system through the BEST software, it is possible to define the unit as a fire alarm call station. In this case, the system will perform the continuous monitoring of all audio and data path, from the microphone capsule up to the wiring to the master unit.</p>
---	--

## 8.3 WG-MTU06 Microphone station

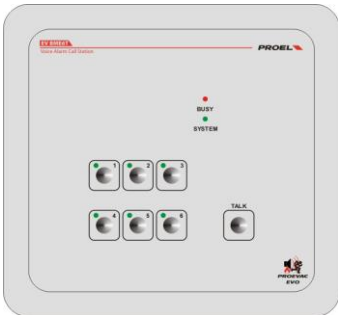
	<p>The WG-MTU06 has 6 selection keys and the TALK button. To broadcast the audio content, first select it by hitting one of the six selection keys, then press TALK. The assignment of the audio content (recorded, spoken, general or alarm) is performed through the BEST software.</p> <p>Each selection key has a led close to it. This will inform the user if the content can be broadcasted or not.</p> <ul style="list-style-type: none"> <li>• <b>GREEN:</b> the selection is ready to be broadcasted.</li> <li>• <b>RED:</b> since the system as the no free resources to process the assigned priority level selection, this can not be broadcasted.</li> <li>• <b>ORANGE:</b> “target change” (see below)</li> <li>• <b>Led OFF:</b> no selection</li> </ul> <p><b>SPECIFIC FEATURES THE WG-MTU06 CALL STATION</b></p> <p><b><u>Juxtaposed contents</u></b></p> <p>The system allows to juxtapose one or more identical contents, with the exception of their destination. This will allow to broadcast the same content over zones or groups by composing the destination.</p> <p><b>EXAMPLE:</b> in case of a hotel, if the key 1 is associated to a chime followed a live spoken announcement on the “Restaurant” zone, and the key 2 is associated to a chime followed by a live spoken announcement (same as key 1) on the “Hall” zone, it is possible to select them both (key 1 and 2) and broadcast the announcement (TALK key) on both zones.</p> <p><b>EXAMPLE:</b> if the key 1 is associated to a chime followed a live spoken announcement on the “Restaurant” zone, and the key 2 to live spoken announcement, but with no chime, on the “Hall” zone, it will not be possible to select them both. In this case the selection of one of the two will cancel the other if previously selected.</p>
	<p><b><u>Destination change</u></b> It is possible to change the broadcasting destination (zone or group) of an audio content. Please consider this example</p>

	<p>A WG-MTU06 call station has been configured as follows:  Key 1: Chime, then live announcement on the “Restaurant” zone  Key 2: Chime, then live announcement on the “Hall” zone  Key 3: Chime, then live announcement on the “Fitness” zone  Key 4: not configured  Key 5: not configured  Key 6: Recorded message on all zones (Reastaurant + Hall + Fitness)</p> <p>If we want to play the recorded message on the “Restaurant” zone only  Step 1: Select the destination, press Key 1; led turns green.  Step 2: Select the recorded message, press Key 6; the selection led turns orange.  Step 3: hit the TALK key to play the message  The recorded message will be played on the “Restaurant” zone only</p> <p>When configuring the system through the BEST software, it is possible to define the unit as a fire alarm call station. In this case, the system will perform the continuous monitoring of all audio and data path, from the microphone capsule up to the wiring to the master unit.</p>
--	--

#### 8.4 EV BME10T Microphone station

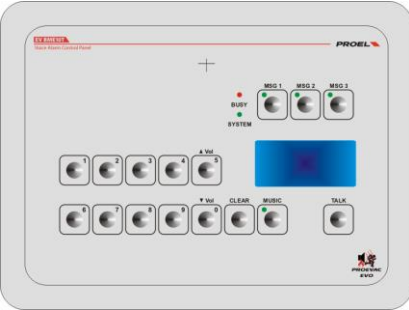
	<p>The EV BME10T call station has a dial keyboard, three direct selection keys, and a dot-matrix display.  To select a destination, please refer to the “phonebook” assignments defined during the configuration through the BEST software. The phonebook will assign a dial code to each destination, zone or group of zones of a specific audio content.  Once the destination is dialed, the display will indicate if the system resource is free or busy and if the content can be broadcasted with the TALK button.</p> <p>As seen with the WG-MTU06, it is possible to change the destination of an audio content.</p> <p><b>EXAMPLE</b>  A EV BME10T is configured as follows:  Selection: Chime + live voice announcement; the zones are defined in the BEST Phonebook  MSG-1 key: “welcome” recorded message on all zones  MSG-2 key: “commercial” recorded message on all zones  MSG-2 key: “special offer” recorded message on all zones  If we want to play the “welcome” message on zone 5 only:  Step 1: Select the zone n. 5 on the selection keyboard  Step 2: : select the “welcome” message (MSG-1 key), the led will turn orange  Step 3: broadcast the message with the TALK key.  The recorded message is broadcasted on zone 5 only.</p> <p>When configuring the system through the BEST software, it is possible to define the unit as a fire alarm call station. In this case, the system will perform the continuous monitoring of all audio and data path, from the microphone station up to the wiring to the master unit.</p>
--	---

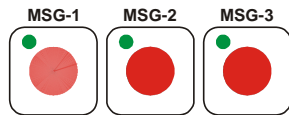

#### Quick selection keys

The EV BME10T has 3 direct-dial selection keys; their operating principle is the same as seen for the selection keys of the WG-MTU06 call station.

To broadcast the associated audio content, first select one of the three, then press the TALK key.

The assignment of audio content to these keys is performed through the BEST software.

Each selection key has a led close to it. This will inform the user if the content can be broadcasted or not.

- **GREEN:** the selection is ready to be broadcasted.
- **RED:** the system has no free resources to broadcast the assigned priority level selection.
- **ORANGE:** “target change” (see below)
- **Led OFF:** no selection

## 9. TECHNICAL SPECIFICATIONS

EV PROM5Z MASTER UNIT	
<b>General</b>	
Layout	Rack mountable steel enclosure with module slots on the rear panel. EN 50102 IP protection: IP30IK4
Dimensions	width: 19" – heith: 2U – depth: 195,5mm
Net weight	4,10 Kg
Front panel user interface	6x navigation keys, LCD graphic160x64 displau, 3x status leds USB Device port
<b>Power Supply</b>	
Input voltage	+24Vdc (min 22Vdc, max 28Vdc)
Rated power	2,64W (110mA @ 24Vdc) – Test conditions: quiescent state, all slots empty, no call stations connected
Power distribution to call stations	2x 24Vdc bypass - max 1,5A on each bus
<b>Extensions and Module Slots</b>	
Zone controllers	4x slots
Extension slots	1x general purpose extension slot for future use
Zone extension	2x RJ45 to EV PROS8Z unit
<b>Audio Inputs</b>	
Call stations busses	<ul style="list-style-type: none"> <li>Balanced 600ohm audio input; 250 ÷ 18.000Hz @ -3dB, 2Vpk max, S/N &gt;80dB</li> <li>RS485 databus</li> <li>+24V power supply, 1,5A max</li> </ul>
AUX background music input	Stereo RCA mixed to mono; 60 ÷ 18.000Hz, 1.8Vpk max signal.S/N S/N >80dB
Digital player	12bit, 32Khz, audio files storage on internal uSD card.
<b>Audio Flow Management</b>	
Architecture	4 lines matrix arrangement, commutation from sources to line modules.
Volume control	-50dB ÷ 0dB
Tone control: bass, middle, treble	-14dB ÷ +14dB
<b>Spare Amplifier Connections</b>	
Description	Automatic management and spare poter amplifier switching Continuous monitoring
Output to spare amplifier	Balanced, tranfomer coupled 600Ω 1.20Vrms, S/N >80dB, THD <1%
Input from spare amplifier	100V output, maximum rated power: 500Wrms
Amplifier monitoring	18Khz, FFT analysis over output voltage, 5% tolerance over calibration value.
<b>Input Contacts and Outputs</b>	
Recorded alarm message trigger	2x inputs, monitored against cable short and cable cut
Relay	1x NO or NC, 1A max





<b>EV PROS8Z SLAVE UNIT</b>	
<b>Generale</b>	
Layout	Rack mountable steel enclosure with module slots on the rear panel. EN 50102 IP protection: IP30IK4
Dimensions	width: 19" – heith: 2U – depth: 195,5mm
Net weight	3,90 Kg
Front panel user interface	2x status leds
<b>Alimentazione</b>	
Input voltage	+24Vdc (min 22Vdc, max 28Vdc)
Rated power	1.3W (55mA @ 24Vdc) – Test conditions: quiescent state, all slots empty,
<b>Extensions and Module Slots</b>	
Zone controllers	8x slots
<b>Spare Amplifier Connections</b>	
Description	Automatic management and spare poter amplifier switching Continuous monitoring
Output to spare amplifier	Balanced, transformer coupled 600Ω 1.20Vrms, S/N >80dB, THD <1%
Input from spare amplifier	100V output, maximum rated power: 500Wrms
Amplifier monitoring	18Khz, FFT analysis over output voltage, 5% tolerance over calibration value.

<b>EV MCL1Z MAIN LINE-A CONTROLLER MODULE</b>	
<b>General</b>	
Layout	PCB Open Frame, with mounting bracket for EV PROM5Z or EV PROS8Z. EN 50102 IP protection: n.a.
Dimensions	85x35x125
Weight	0,18 Kg
<b>Main Amplifier Management</b>	
Description	The module manages and performs the monitoring of the main power amplifier and loudspeaker line. In case of a fault to the main amplifier, the system automatically switched over the spare amplifier (if installed)
Rated power	0.72W (30mA @ 24Vdc) – Test conditons: idle state
Line output to power amplifier	Balanced, transformer coupled 600Ω 1.20Vrms, S/N >80dB, THD <1%
Power input from amplifier	100V output, maximum rated power: 500Wrms
Amplifier monitoring	18Khz, FFT analysis over output voltage, 5% tolerance over calibration value.
<b>100V Loudspeaker Line</b>	
Output	100V loudspeaker line; maximum rated power: 500Wrms
Line monitoring	18Khz, FFT analysis over output voltage and current, 5% tolerance over calibration value.
<b>Digital Player</b>	
Description	12bit, 32Khz, audio files storage on the onboard embedded memoru, max 2 messagges 60sec each
Recorded alarm message trigger	2x inputs, monitored against cable short and cable cut



<b>EV MCL1Z REDUNDANT LINE-B CONTROLLER MODULE</b>	
<b>General</b>	
Layout	PCB Open Frame, with mounting bracket for EV PROM5Z or EV PROS8Z. EN 50102 IP protection: n.a.
Dimensions	85x35x125
Weight	0,11 Kg
<b>Line B Management – Needs matching to EV MCL1Z</b>	
Description	The unit manages the redundant loudspeaker line together with the main line controller EV MCL1Z. The power amplifier is shared by both units and is managed by the EV MCL1Z unit.
Rated power	0.67W (28mA @ 24Vdc) – Test conditions: idle state
<b>100V Loudspeaker line</b>	
Output	100V loudspeaker line; maximum rated power: 500Wrms
Line monitoring	18Khz, FFT analysis over output voltage and current, 5% tolerance over calibration value.

<b>EV BME1T MICROPHONE CALL STATION</b>	
<b>General</b>	
Layout	Steel chassis with brushed and anodized top panel EN 50102 IP protection: IP31IK4
Dimensions	140x190x50 – Gooseneck length 330mm
Weight	1,05 Kg
Description	Dynamic microphone digitally controlled call station. Mic gain settable by dedicated trimmer, automatic compressor/limiter, continuous monitoring of the microphone capsule
Frequency response	250Hz – 12Khz @ -3dB S/N >80dB
Power	1,2W (50mA @ 24Vdc) – Test conditions: idle state
Connections	RJ45 plug to EV PROM5Z master unit
Microphone capsule monitoring	Open circuit / Short circuit
User interface	1x key – 2x leds

<b>WG-MTU06 MICROPHONE CALL STATION</b>	
<b>Generale</b>	
Layout	Steel chassis with brushed and anodized top panel EN 50102 IP protection: IP31IK4
Dimensions	190x190x50 – Gooseneck length 330mm
Weight	1,35 Kg
Description	Dynamic microphone digitally controlled call station. Mic gain settable by dedicated trimmer, automatic compressor/limiter, continuous monitoring of the microphone capsule
Frequency response	250Hz – 12Khz @ -3dB S/N >80dB
Power	RJ45 plug to EV PROM5Z master unit
Connections	1,2W (50mA @ 24Vdc) – Test conditions: idle state
Microphone capsule monitoring	Open circuit / Short circuit
User interface	7x key – 8x leds



<b>EV BME10T MICROPHONE CALL STATION</b>	
<b>Generale</b>	
Layout	Steel chassis with brushed and anodized top panel EN 50102 IP protection: IP31IK4
Dimensions	225x190x50 – Gooseneck length 330mm
Weight	1,6 Kg
Description	Dynamic microphone digitally controlled call station. Mic gain settable by dedicated trimmer, automatic compressor/limiter, continuous monitoring of the microphone capsule
Frequency response	250Hz – 12Khz @ -3dB S/N >80dB
Power	RJ45 plug to EV PROM5Z master unit
Connections	2,0W 850mA @ 24V(dc) – Test conditions: idle state
Microphone capsule monitoring	Open circuit / Short circuit
User interface	16x keys – 6x leds - LCD 160x64 dot-matrix display



## 10. CERTIFICATIONS

The following table lists the options with requirements implemented by the Proevac system according to EN54-16:2008 Annex B, Table B1

Option	Clause/subclause	Implementation
Audible Warning	7.3	YES
Delay(s) to entering alarm condition	7.4	NO
Phased evacuation	7.5	NO
Manual silencing of the voice alarm condition	7.6.2	YES
Manual reset of the voice alarm condition	7.7.2	YES
Output to fire alarm devices	7.8	NO
Voice alarm condition output	7.9	NO
Indication of faults related to the transmission path of the CIE	8.3	NO
Indication of the fault related to voice alarm zones	8.4	YES
Disablement condition	9	NO
Voice alarm manual control	10	YES
Interface to external control devices	11	NO
Emergency microphones	12	YES
Redundant power amplifiers	13.14	YES



068-CPD-xxx/2014

**Proel Spa**

Via alla Ruenia 37/43, 64027 Sant'Omero (TE) – Italy

Year In which this marking was affixed: 201a

**EN 54-16:2008**

**PROEVAC EVO**

Voice alarm control and indicating equipment for use in fire detection and fire alarm systems installed in buildings.

**Provided options:**

Audible warning - Manual silencing of voice alarm  
Manual rest of voice alarm - Voice alarm manual control  
Emergency microphones - Redundant power amplifiers

Other technical data held by the manufacturer:  
"PROEVAC EVO Documentantion Files Rev 1.00"

**WARRANTY CONDITIONS**

Sotis Engineering, according to European Community Laws and Directives, warrants that this product is free from defects in both materials and craftsmanship for a period of 2 (two) years.

The warranty for the Proevac product range described in this manual is valid only if the item carries the model name and serial number originally applied by the manufacturer, Sotis Engineering. Any alteration, cancelling, modification or removal of the product identification and labelling applied on the product will void any warranty.

Warranty is void if modifications or repairs are made by any third party or by personnel that was not authorized by Sotis Engineering.

Warranty covers all defects due to materials or craftsmanship and is limited to the repair or replacement of the faulty items, at the discretion of Sotis Engineering. To qualify for warranty, the product must be sent to Sotis Engineering Srl together with a proof of purchase (invoice or delivery note). Proof of purchase shall also include the serial number of the device. Shipping costs, labor, removal of the device are responsibility of the purchaser. The purchaser must ensure that the goods shipped for warranty repairs are properly packed in their original packaging. Any damage due to transportation is at the risk of the sender.

The warranty will not cover the following: accidental damage; damage caused or resulting from carelessness, neglect, misuse or abuse of the product; damages resulting from the use of the product with a supply voltage other than that indicated on the product and in this manual; damage from connections that do not follow the guidelines indicated in this manual; damage caused by modification or alteration of the product; damages caused by the usage of the product under electrical, mechanical and environmental conditions other than indicated in this manual; damage caused by fire, earthquake, flood, or majeure force; damage caused by transportation, damage caused by improper handling or installation; damage to the product finish; damage resulting from failure to observe the warnings provided in this manual; damage from liquids, chemicals and atmospheric events.

Warranty excludes any compensation or refund to the purchaser, seller or distributor, for all damages to any other good or property consequential to the product failure.

Sotis Engineering is not responsible for any damage to persons, animals or property related or dependent from the usage of the product.

For any dispute, the applicable Law is the Italian Law and the place of jurisdiction is Torino, Italy.

#### DISCLAIMER

Proevac is manufactured by Sotis Engineering Srl in compliance with international standards in terms of safety, performance and in compliance with the requirements of the European Community. For proper and effective use of the product, it is important to be aware of its features and its operating procedures described in this manual, especially the safety notes.

Sotis Engineering Srl disclaims all liability for damage and/or injury resulting from incorrect use or misuse of its products or procedures that do not comply with the instructions in this manual.

The pictures, figures and images in this manual are only representative and do not constitute a reference for product identification in compliance to regulatory requirements.

To identify the products, items and parts of the WauGuard system, please refer only to Annex 1 to the Certificate of Constance of Performance n. 0068-CPR-014/2013 Rev. 1.

In the continuous effort to improve its products, Sotis Engineering Srl reserves the right to make changes or modifications to their products, their specifications, technical drawings, documentation and manuals at any time and without notice.



#### Instructions for the disposal of the product in accordance with European Directive 2002/96/EC

At the end of its useful life, the product must not be disposed in household waste but must be taken to a special collection area provided by local government or at private facility that provides disposal service. Proper disposal of the electrical and electronic equipment waste (WEEE) avoids possible negative consequences to the environment and people's health and enables to recycle the materials for a significant saving of resources.